

**DFC DF-915FM5B87CB: 89BH5@**  
 H:9 B: CFA 5HC B 7 C B15 B98 B H:6  
 8F5K B: 6H:9 GC @DFC D9FHMC:  
 OBG9FH7 CA D5BMB5A 9<9F92" 5BM  
 F9DFC 81 7 HC B B D5FHCF 5G5 K <C @  
 K H:C1 H:9K F H9B D9FA 6GC B C:  
 OBG9FH7 CA D5BMB5A 9<9F92 6  
 DFC <6#98\*

		I B @GGC H:9FK 69 GD97 ÷ 98.	B5A 9	85H9	("5@ A B1A 7M@B89F H#@.
		8 A 9BG@ BG5F9 B B7 <9G HC @F5B7 9G : F57 HC B5@± 5B: I @5F: A 57 <±.....69B8 ± HK C D@57 9897 A 5@± H:KF99D@57 9897 A 5@±	8F5K B		
		B H9FDF9H: 9C A 9F7 HC @F5B7 B: D9F. A 5H9F 5@	7 <97 ?98		G#9 8K ; "BC" F9J <b>5</b>
	B9LH5GGM	I G98 C B	9B: 5DDF"		
	5DD@7 5HC B	8C B CHG7 5 @98F5K B:	A: : 5DDF"		
		: B 6<	E "5"		
			7 C A A 9BHG		

)

(

&

%

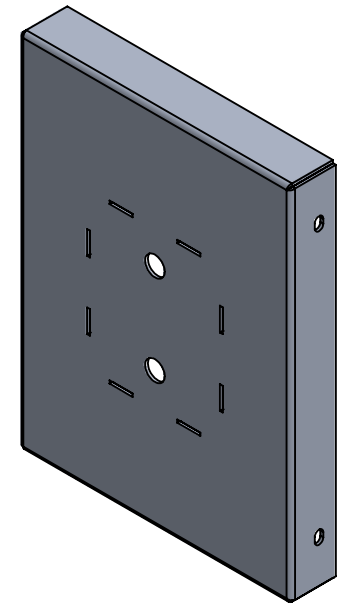
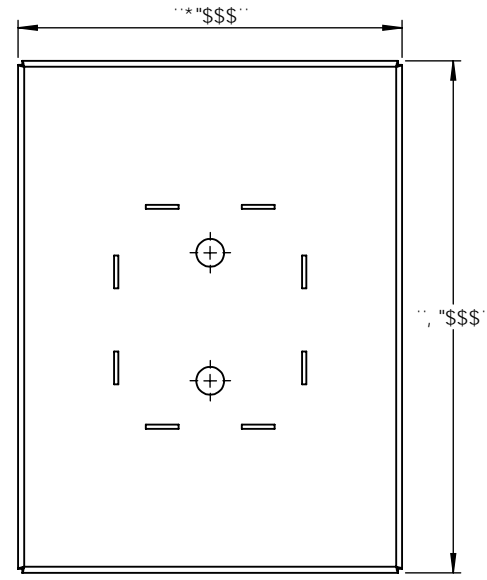
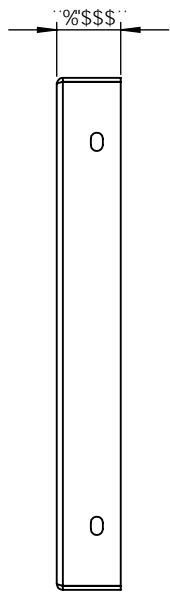
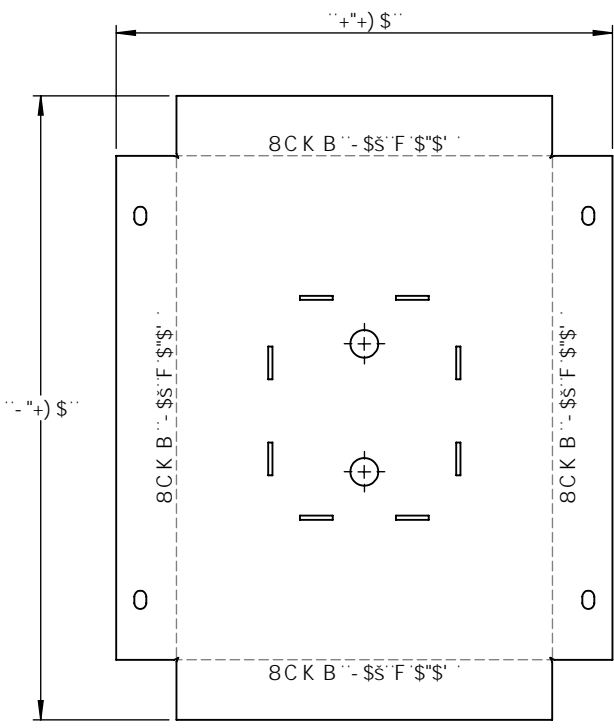
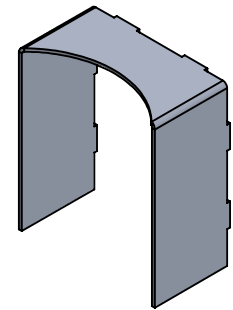
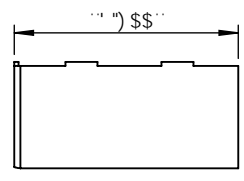
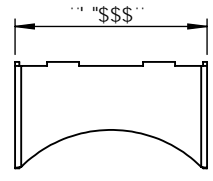
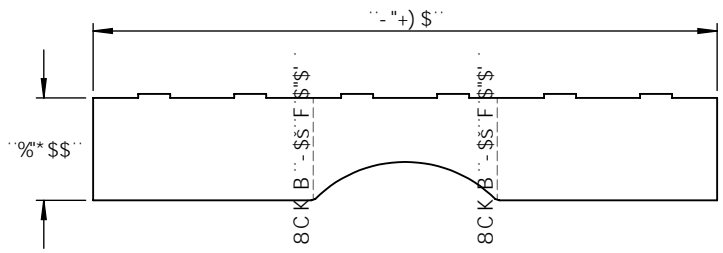

DFC DF-5FM5B87CB: 89BH5@  
 H:9 B: CFA 5HC B 7 C B H 5 B 98 B H 6  
 8F5K B: 6H:9GC @DFC D9F HMC:  
 OB G9FH7 CA D5BMB5A 9<9F92" 5BM  
 F9DFC 81 7 HC B B D5FHCF 5G5 K <C @  
 K H: C1 H: 9K F H9B D9FA 6GC B C:  
 OBG9FH7 CA D5BMB5A 9<9F92 6  
 DFC <6H98"

		I B @GGCH:9FK 69GD97 ÷ 98.		B5A 9	85H9
		8 A 9BG C BG5F9 B B7 <9G HC @F5B7 9G : F57 HC B5 @± 5B: I @F: A 57 <± .....69B8 ± HK C D @57 9897 A 5 @± H: F99D @57 9897 A 5 @±	8F5K B 7 <97 ?98 9B: 5DDF" A: : 5DDF"		
		B H9FDF9H: 9C A 9F 7 HC @F5B7 B: D9F.	E "5" 7 C A A 9BHG		
		A 5H9F 5@			
B9LH5GGM	I G98 CB	: B 6<			
	5DD@7 5HC B	8C B CHG75 @98F5K B:			

5 @ A B I A '\$\$*' ) "		
H#@.		
5 @HK @ *!(K !56!K :!65FA !(%)		
G#9 <b>5</b>	8K ; "'BC"	F9J
G7 5 @. %'	K 9 ÷ <H'	G<99H) 'C: '-

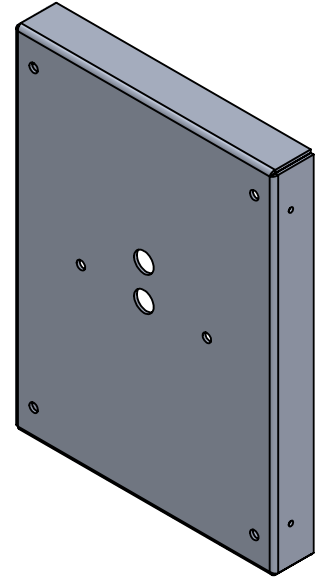
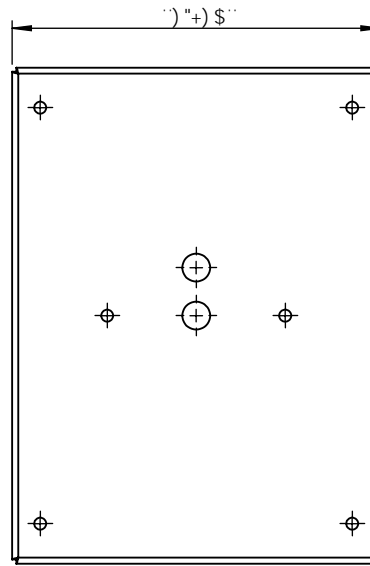
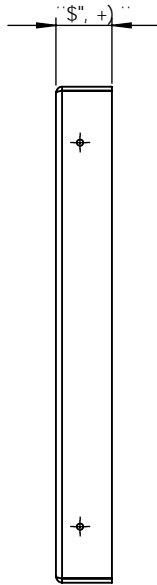
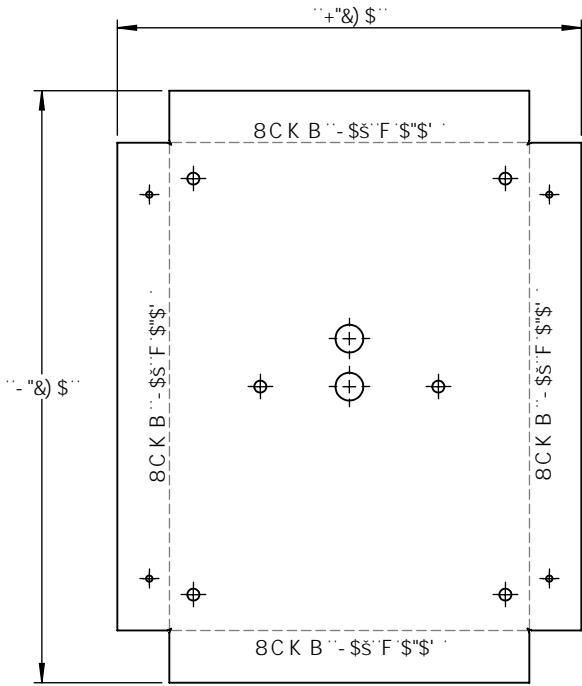
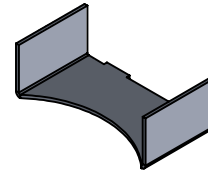
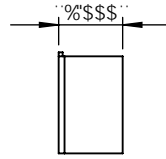
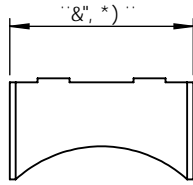
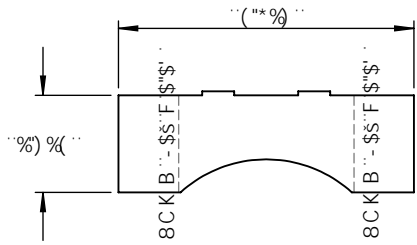

DFC DF-5FM5B87CB: 89BH5@  
 H:9 B: CFA 5HC B 7 C BH5 B98 B H:6  
 8F5K B: 6H:9GC @DFC D9FHVC:  
 OB9FH7CA D5BMB5A 9<9F92" 5BM  
 F9DFC 817HC B-B D5FHCF 5G5 K <C @  
 K H:C1 H:9K F H9B D9FA 6GC B C:  
 O:BG9FH7CA D5BMB5A 9<9F92 6  
 DFC <6H98"

		I B @GGCH:9FK 69GD97 ÷ 98.		B5A 9	85H9
		8A 9BG C BG5F9 B B7 <9G HC @F5B7 9G :F57HC B5@± 5B: I @5F: A 57 <±.....69B8 ± HK C D@579897 A 5@± H:F99D@579897 A 5@±	8F5K B 7 <97 ?98 9B: 5DDF" A: : 5DDF"		
		B:H9DF9H: 9CA 9F7 HC @F5B7 B: D9F. A 5H9F 5@	E "5" 7 C A A 9BHG		
B9LH5GGM	I G98 CB	:B<			
	5DD@7 5HC B	8C BCHG75@98F5K B:			

5@A BIA '\$\$*' ) "		
H#@.		
5@HK @ *!(K !56!K :!65FA !(%)		
G#9 <b>5</b>	8K ; "'BC"	F9J
G7 5 @. %'	K 9 ÷ <H'	G<99H* 'C : '-

)

(

&

%

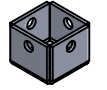
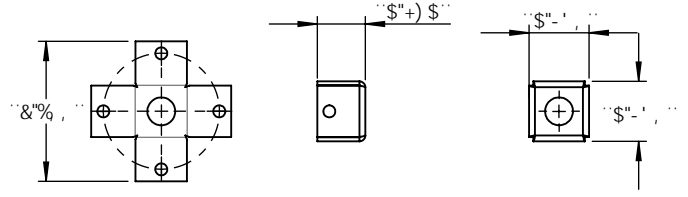
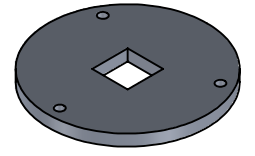
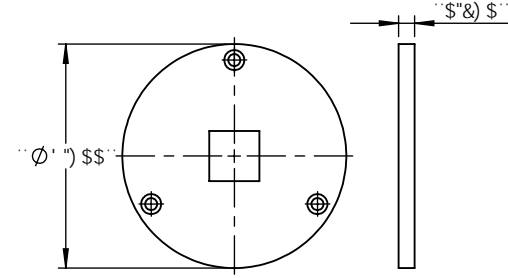
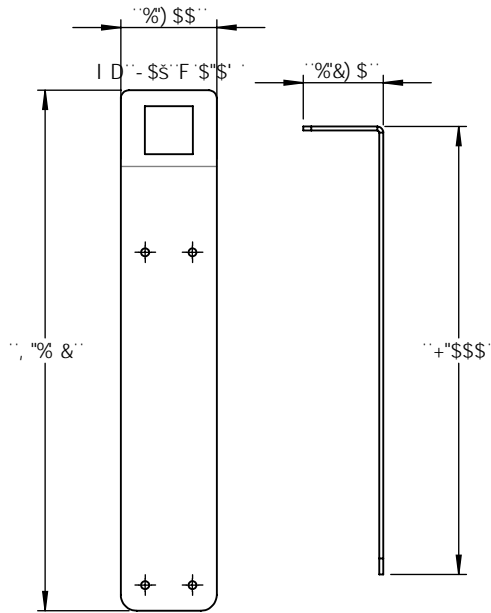
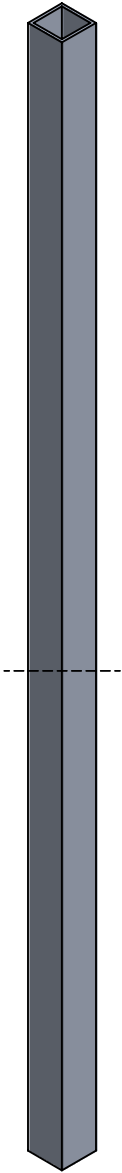
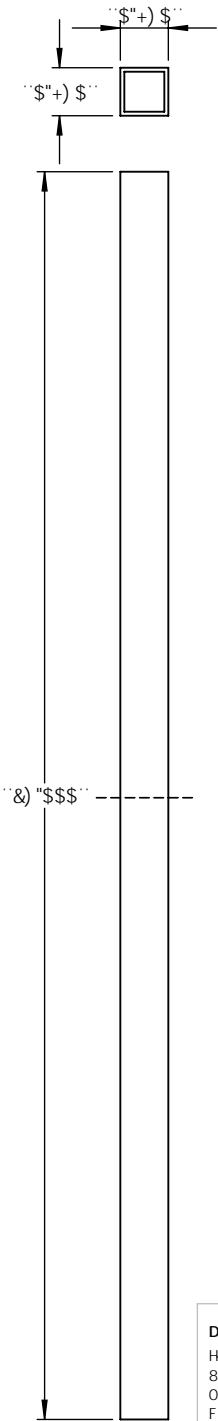

**DFC DF-9H5FM5B87CB: 89BH5@**  
 H:9 B: CFA 5HC B 7 C B H5 B 98 B H:6  
 8F5K B: 4GH:9GC @DFC D9FHVC:  
 OBG9FH7 CA D5BMB5A 9<9F92" 5BM  
 F9DFC 81 7 HC B B D5FHCF 5G5 K <C @  
 K 4: C1 H:K 9K F H9B D9FA 6GC B C:  
 OBG9FH7 CA D5BMB5A 9<9F92 6  
 DFC <6#98\*

		I B @GGCH:9FK 69GD97 ÷ 98.	B5A 9	85H9	5 @ A B I A "\$&)" \$""D@5H9
		8 A 9BG@BG5F9 B B7 <9G HC @F5B7 9G : F57 HC B5 @± 5B: I @F: A 57 <± ""69B8 ± HK C D@57 9897 A 5@""± H:F99D@57 9897 A 5@±	8F5K B		
		B H9DF9H: 9C A 9F 7 HC @F5B7 B: D9F.	7 <97 98		5 @HK @ *!&(K !56!K :!65FA !(%?
		A 5H9F 5@	9B: 5DDF"		
B9LH5GGM	I G98 CB	: B@<	A: : 5DDF"		
		8C BCHG75 @98F5K B:	E "5"		
	5DD@7 5HC B		7 C A A 9BHG		
					G#9 8K ; ""BC"
					F9J
					G7 5 @. %' K 9 ÷ <H'
					G<99H+C: '-

#9A 'BC "	D5FHBI A 69F	89G7 F-DHC B	E HM
%	5@HK @ *!(K !56!K :!65FA !(%?!GDI B '75D	GDI B '5@ A -BI A '\$\$*' ) "	%

#9A 'BC "	D5FHBI A 69F	89G7 F-DHC B	E HM
%	5@HK @ *!(K !56!K :!65FA !(%?!GDI B '-BB9F '75D	GDI B '5@ A -BI A '\$\$*' ) "	%

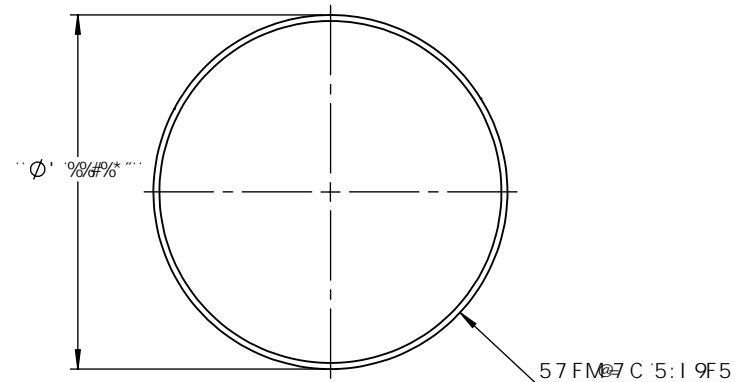
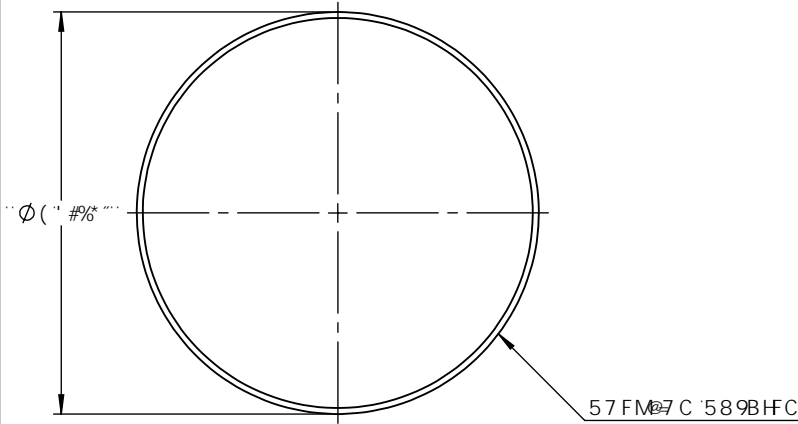
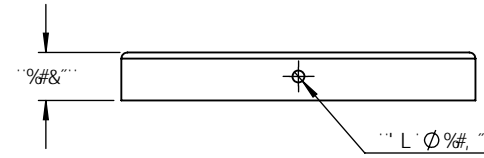
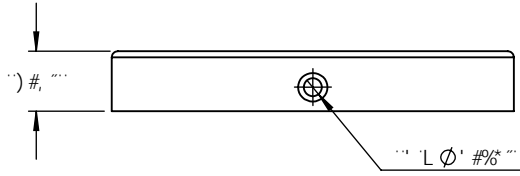
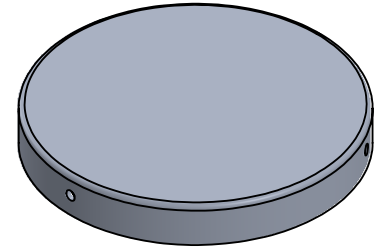
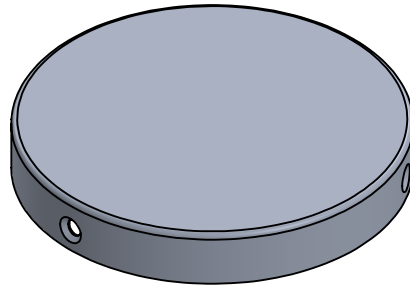

D5FHBI A 69F  
 H-9 B: CFA 5HC B 7 C BI5-B98 -B H-6  
 8F5K B: 6H-9GC @DFC D9FHMC:  
 OBG9FH7 CA D5BMB5A 9<9F92" 5BM  
 F9DFC 81 7 HC B -B D5FHCF 5G5 K <C @  
 K H-C1 HH-9K F H9B D9FA 6GC B C:  
 OBG9FH7 CA D5BMB5A 9<9F92 -G  
 DFC <6#98"

		I B @GGC H: 9FK 69 GD97 ÷ 98.	B5A 9	85H9	GDI B '5@ A -BI A '\$\$*' ) "
		8-A 9BG C BG5F9-B -B7 <9G HC @F5B7 9G : F57 HC B5 @± 5B: I @5F: A 57 <± .....69B8 ± HK C D@57 9897 -A 5@± H: F99D@57 9897 -A 5@±	8F5K B		H#@.
		BH9DF9H: 9C A 9F 7 HC @F5B7 B: D9F.	7 <97 ?98		5@HK @ *!(K !56!K :!65FA !(%?
		A 5H9F 5@	9B: 5DDF"		
		: B@<	A: : 5DDF"		
			E "5"		
			7 C A A 9BHG		
B9LH5GGM	I G98 C B				G#9 8K ; "'BC "
					F9J
					G7 5 @. %& K 9 ÷ <H'
					G<99H, 'C: '-

)

(

&

%



#PA BC "	D5FHBI A 69F	8 9G7 F-DHC B	E HM
%	5@HK @ *!&(K !56!K :!65FA !(%?!H 69G@9J 9	GDI B 5@ A B! A "\$\$, \$"	%

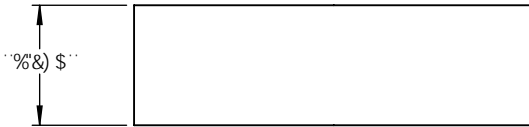
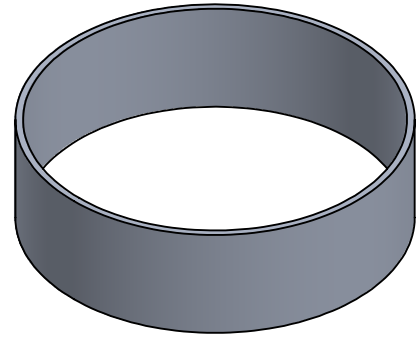
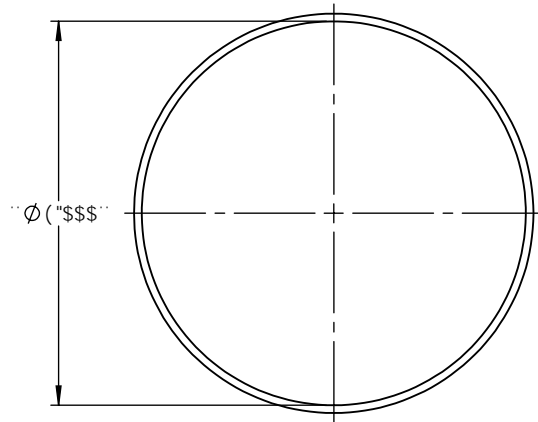

**DFC DF-915FM5B87CB: 89BH5@**  
 H:9 B: CFA 5HC B 7 C B!5-B98-B H:6  
 8F5K B: 4G:9GC @DFC D9FHMC:  
 OBG9FH7 CA D5BMB5A 9<9F92" 5BM  
 F9DFC 81 7 HC B-B D5FHCF 5G5 K <C @  
 K H:C I H:9K F H@B D9FA GGC B C:  
 OBG9FH7 CA D5BMB5A 9<9F92-G  
 DFC <6#98"

		I B @GGCH:9FK 69GD97 ÷ 98.	B5A 9	85H9	GDI B '5@ A B! A "\$\$, \$"
		8-A 9BG@BG5F9-B-B7<9G HC @F5B7 9G :F57 HC B5@± 5B: I @5F: A 57 <±.....69B8 ± HK C D@57 9897-A 5@±± H:F99D@57 9897-A 5@±	8F5K B		
		BH@DF9H: 9CA 9F 7 HC @F5B7 B: D9F.	7 <97 ?98		5@HK @ *!&(K !56!K :!65FA !(%?
		A 5H@F 5@	9B: 5DDF"		
		:B@<	A: : 5DDF"		G#9 8K ; "'BC" F9J
			E "5"		
			7 C A A 9BHG		G7 5 @. '%& K 9 ÷ <H' G<99H- 'C: '-
	B9LH5GGM	I G98 C B			
	5DD@7 5HC B	8C B@HG7 5@98F5K B:			

)

(

&

%