

ITEM NO.	PART NUMBER	DESCRIPTION	QTY.	CUT
1	GDC0-4WLSR-20LED-MN-WF-14-35K- FRAME ACCENT PLATE	ALUMINUM 0.125" PLATE	1	
2	GDC0-4WLSR-20LED-MN-WF-14-35K- FRAME PLATE	ALUMINUM 0.0635"	1	
3	GDC0-4WLSR-20LED-MN-WF-14-35K-BACK PLATE	ALUMINUM 0.0635"	1	
4	GDC0-4WLSR-20LED-MN-WF-14-35K-FRAME BRACKET	ALUMINUM 0.0635"	1	
5	GDC0-4WLSR-20LED-MN-WF-14-35K-FRAME SPACER TAB	ALUMINUM 0.0635"	4	
6	GDC0-4WLSR-20LED-MN-WF-14-35K-FRAME	ALUMINUM 0.0635"	1	
7	GDC0-4WLSR-20LED-MN-WF-14-35K-LED SPACER	ALUMINUM 0.0635"	1	
8	GDC0-4WLSR-20LED-MN-WF-14-35K-BACKPLATE	ALUMINUM 0.0635"	1	
9	GDC0-4WLSR-20LED-MN-WF-14-35K-FIREPLATE	ALUMINUM 0.0635"	1	
10	GDC0-4WLSR-20LED-MN-WF-14-35K-FRAME TAB	25 GAUGE	4	
11	GDC0-4WLSR-20LED-MN-WF-14-35K-SIDE ACRYLIC	ACRYLIC	1	
12	GDC0-4WLSR-20LED-MN-WF-14-35K-ACRYLIC	ACRYLIC	1	
13	KTLD-25-UV-700-VDIM-LA1	DRIVER	1	
14	AlfaLED_PN1011_RevB	LED	4	

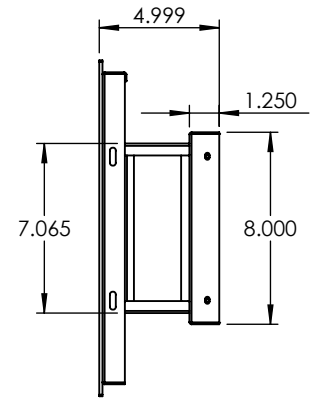
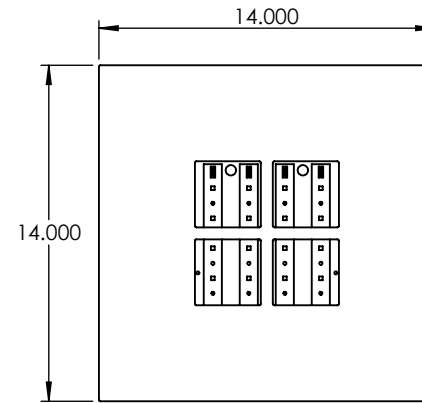
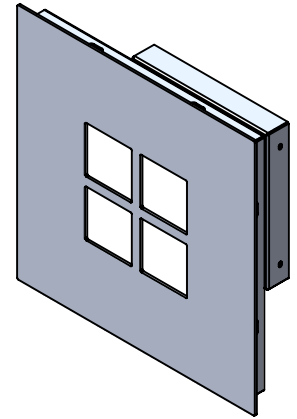
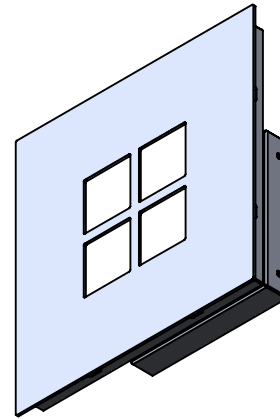
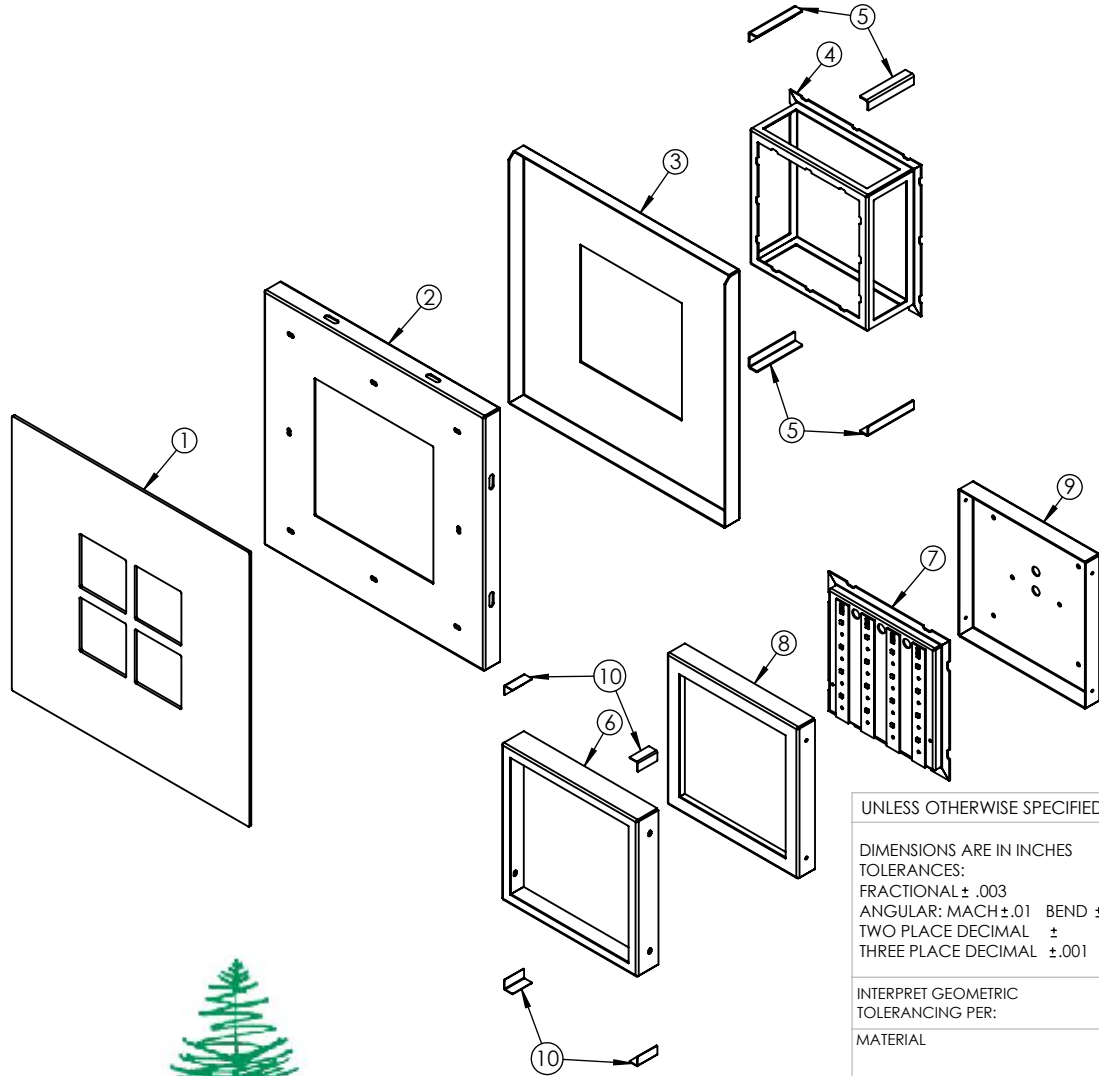

UNLESS OTHERWISE SPECIFIED:

DIMENSIONS ARE IN INCHES
 TOLERANCES:
 FRACTIONAL ± .003
 ANGULAR: MACH ± .01 BEND ±
 TWO PLACE DECIMAL ±
 THREE PLACE DECIMAL ± .001

INTERPRET GEOMETRIC
 TOLERANCING PER:

MATERIAL

FINISH

	NAME	DATE
DRAWN		
CHECKED		
ENG APPR.		
MFG APPR.		
Q.A.		

COMMENTS:

TITLE:

GDC0-4WLSR-20LED-MN-WF-14-35K

SIZE DWG. NO. REV

A TICKET 24498

SCALE: 1:8 WEIGHT: SHEET 1 OF 10



ALL BEND RADIUS .030"

APPLICATION

DO NOT SCALE DRAWING

5

4

3

2

1

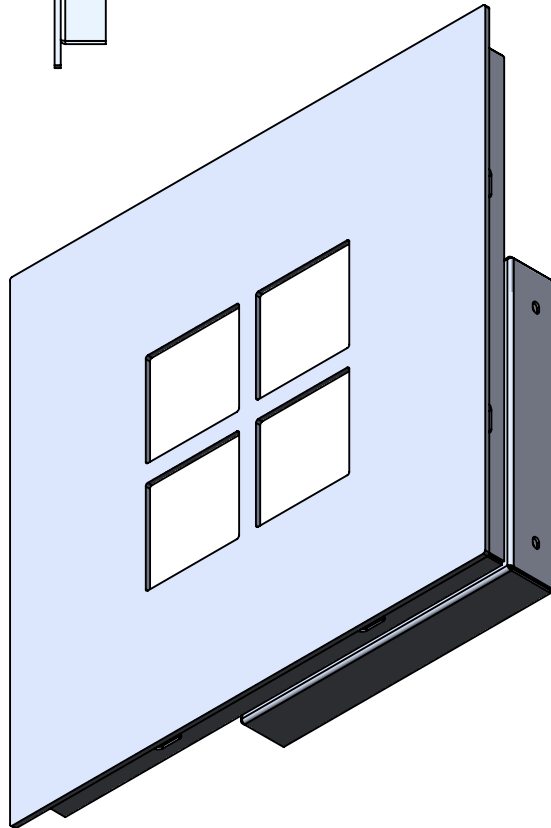
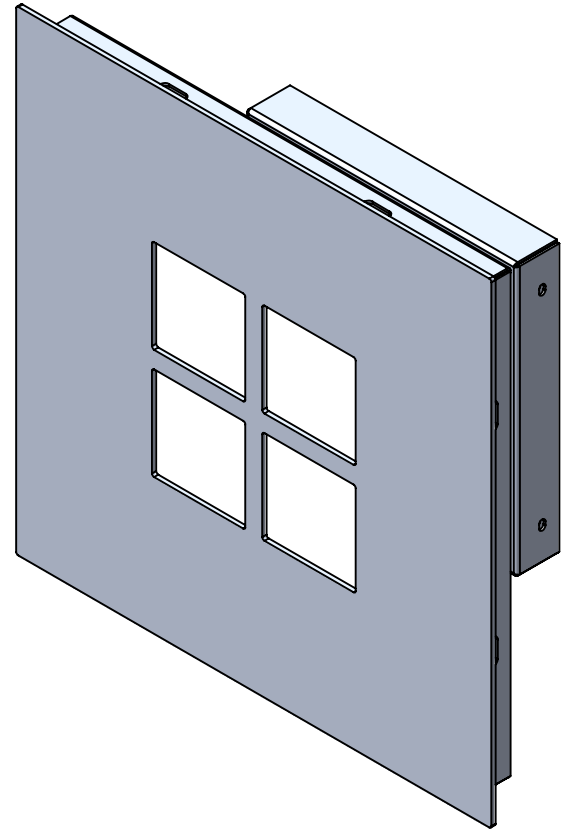
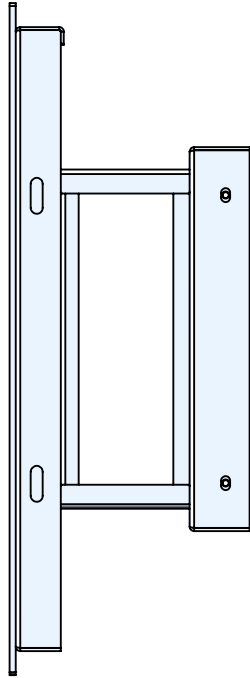
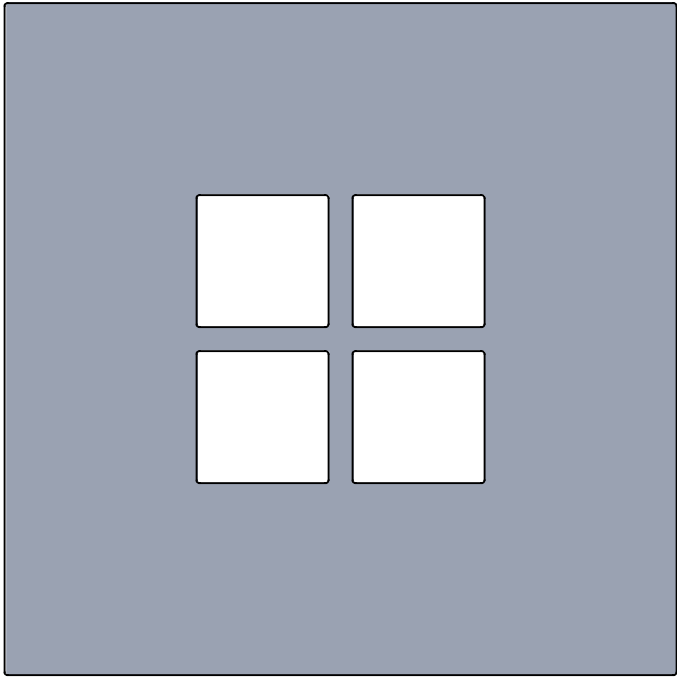

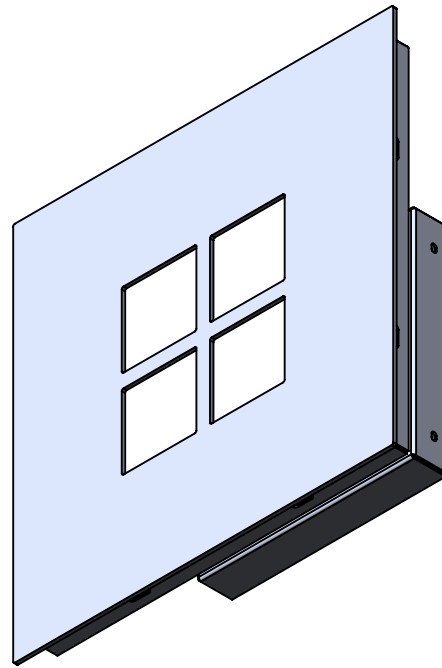
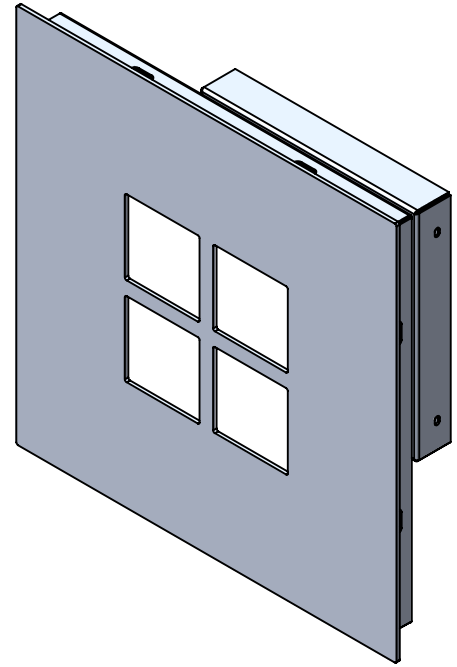
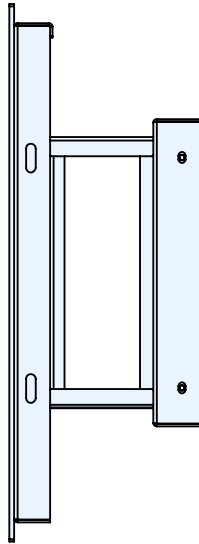
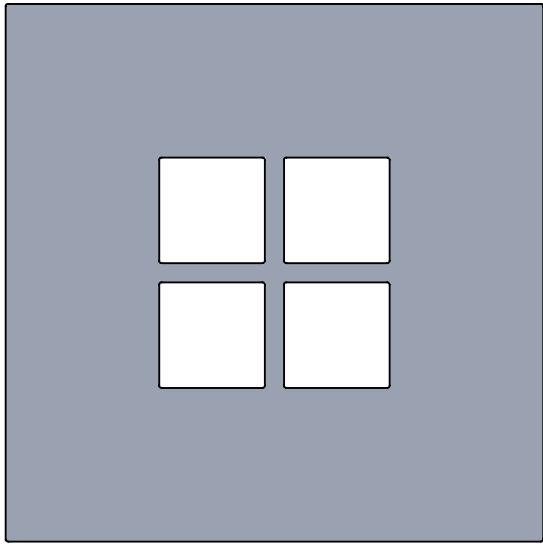

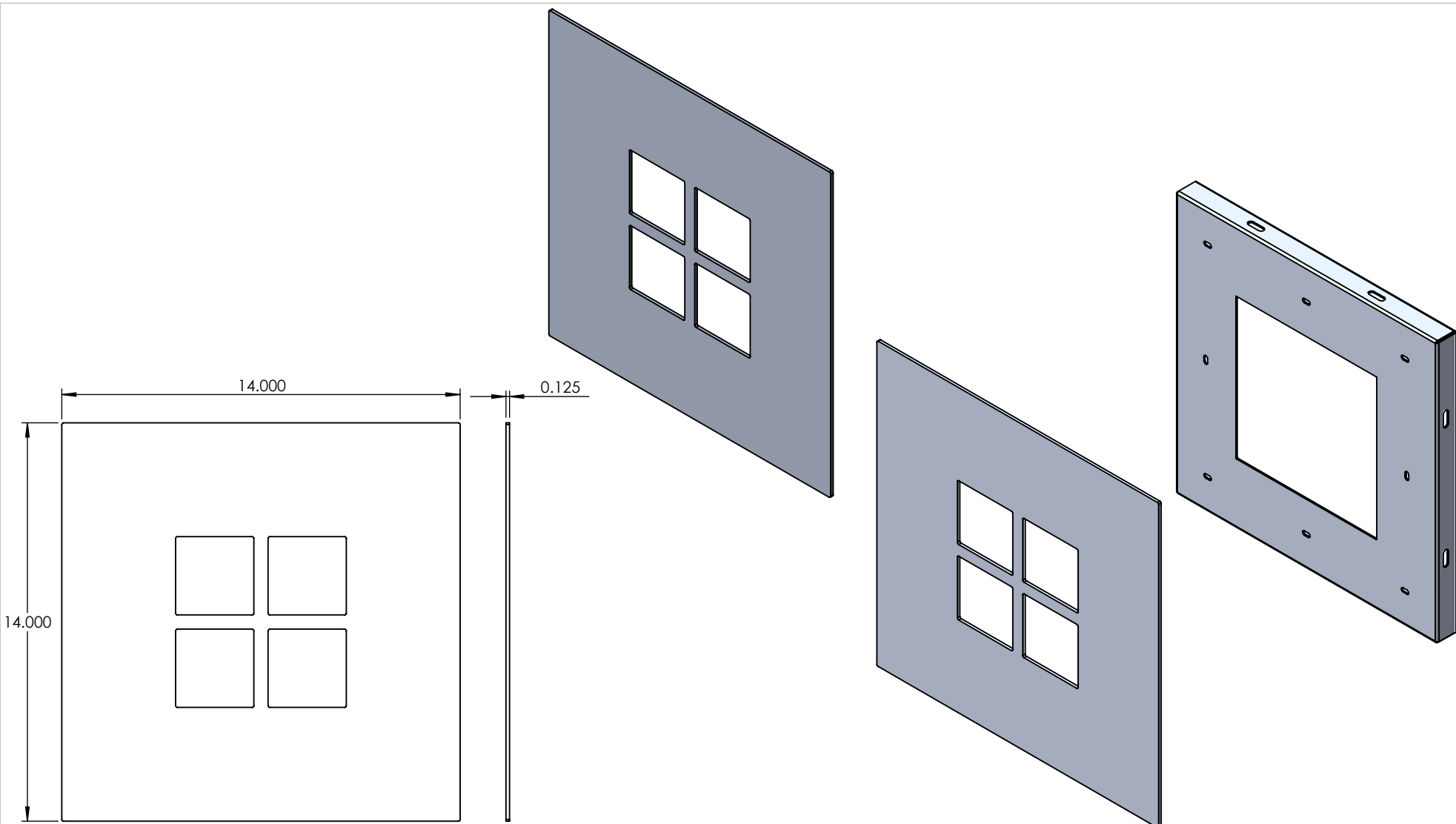

PROPRIETARY AND CONFIDENTIAL
 THE INFORMATION CONTAINED IN THIS DRAWING IS THE SOLE PROPERTY OF <INSERT COMPANY NAME HERE>. ANY REPRODUCTION IN PART OR AS A WHOLE WITHOUT THE WRITTEN PERMISSION OF <INSERT COMPANY NAME HERE> IS PROHIBITED.

		UNLESS OTHERWISE SPECIFIED:		NAME	DATE
		DIMENSIONS ARE IN INCHES	DRAWN		
		TOLERANCES:	CHECKED		
		FRACTIONAL ±	ENG APPR.		
		ANGULAR: MACH ± BEND ±	MFG APPR.		
		TWO PLACE DECIMAL ±	Q.A.		
		THREE PLACE DECIMAL ±	COMMENTS:		
		INTERPRET GEOMETRIC TOLERANCING PER:			
		MATERIAL			
		FINISH			
NEXT ASSY	USED ON				
APPLICATION		DO NOT SCALE DRAWING			

ALUMINUM 0.125" PLATE		
TITLE:		
GDC0-4WLSR-20LED-MN-WF-14-35K		
SIZE	DWG. NO.	REV
A		
SCALE: 1:5	WEIGHT:	SHEET 4 OF 10

5

4

3

2

1

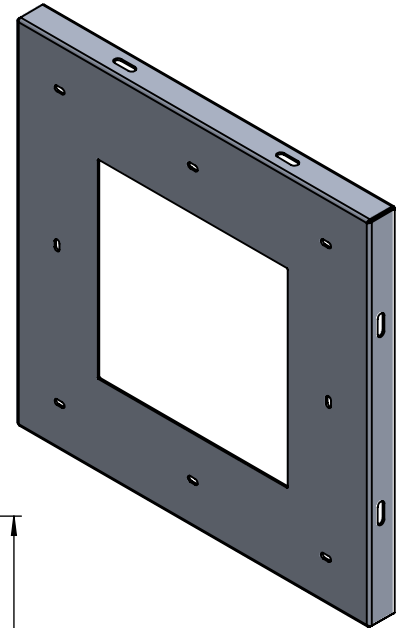
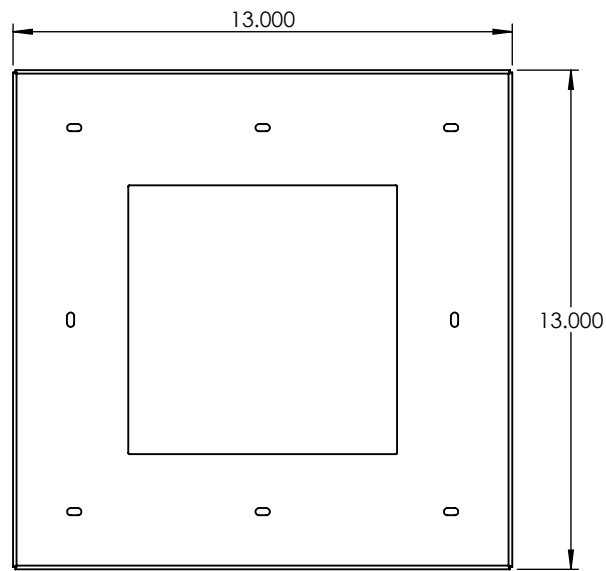
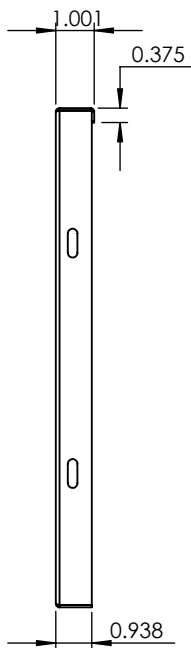
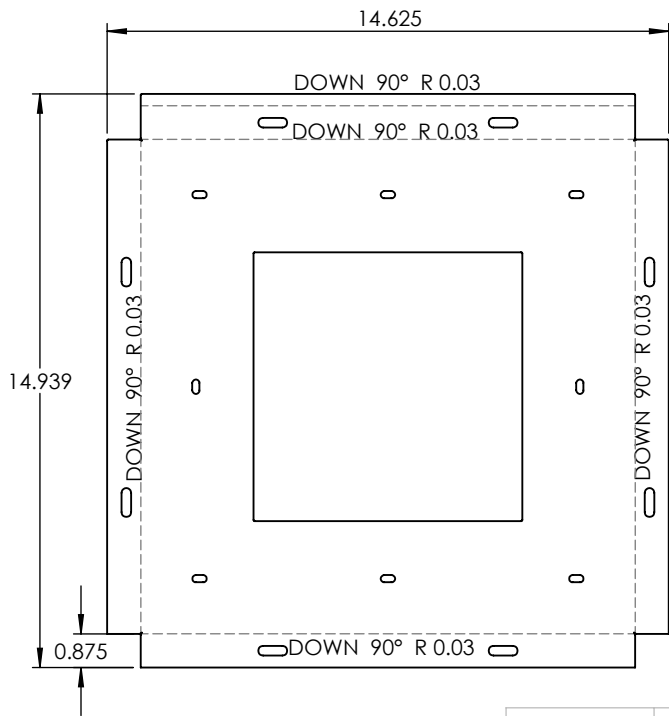

PROPRIETARY AND CONFIDENTIAL
 THE INFORMATION CONTAINED IN THIS DRAWING IS THE SOLE PROPERTY OF <INSERT COMPANY NAME HERE>. ANY REPRODUCTION IN PART OR AS A WHOLE WITHOUT THE WRITTEN PERMISSION OF <INSERT COMPANY NAME HERE> IS PROHIBITED.

		UNLESS OTHERWISE SPECIFIED:	NAME	DATE	ALUMINUM 0.0635"	
		DIMENSIONS ARE IN INCHES TOLERANCES: FRACTIONAL ± ANGULAR: MACH ± BEND ± TWO PLACE DECIMAL ± THREE PLACE DECIMAL ±	DRAWN			
		INTERPRET GEOMETRIC TOLERANCING PER:	CHECKED		GDC0-4WLSR-20LED-MN-WF-14-35K	
		MATERIAL	ENG APPR.			
		FINISH	MFG APPR.		SIZE	DWG. NO.
NEXT ASSY	USED ON		Q.A.		A	REV
APPLICATION		DO NOT SCALE DRAWING	COMMENTS:		SCALE: 1:5	WEIGHT:
5	4	3	2	1	SHEET 5 OF 10	

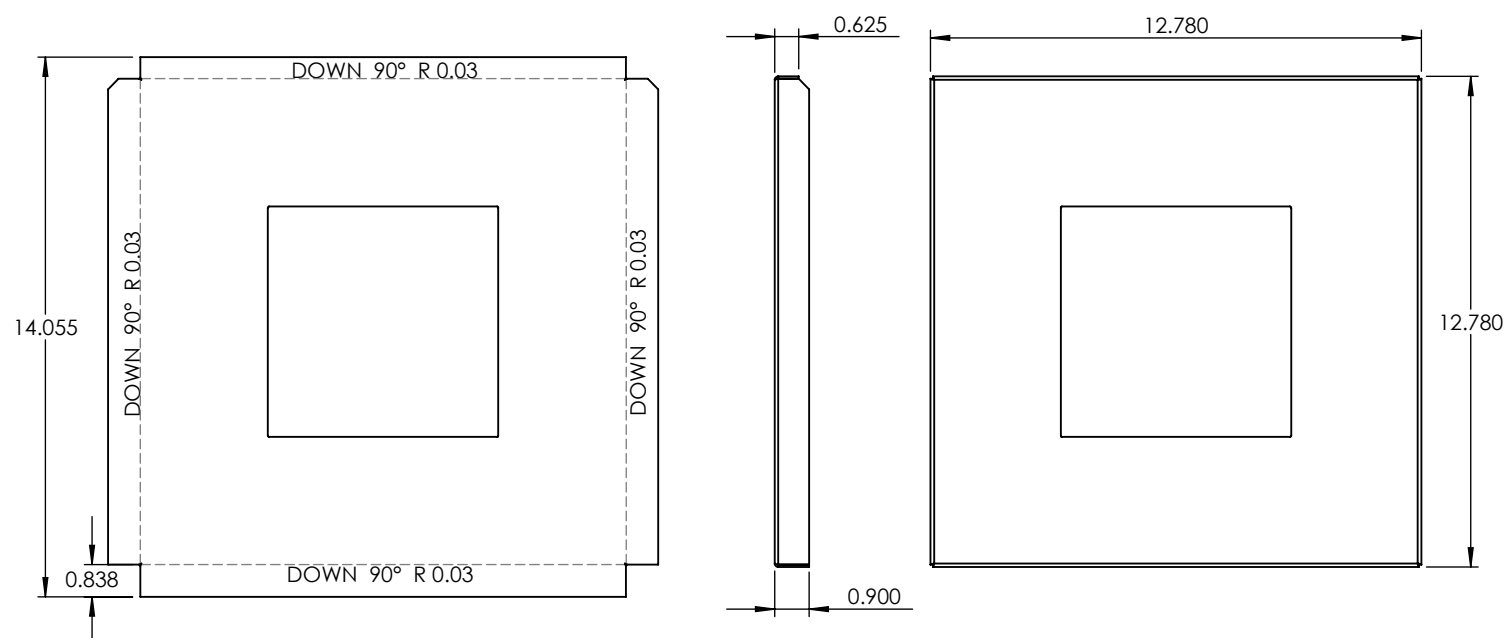
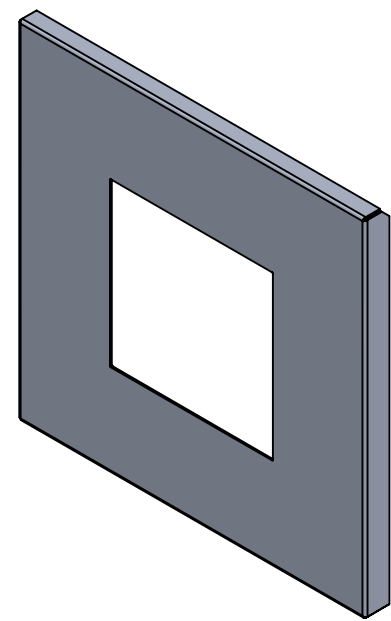

PROPRIETARY AND CONFIDENTIAL
 THE INFORMATION CONTAINED IN THIS DRAWING IS THE SOLE PROPERTY OF <INSERT COMPANY NAME HERE>. ANY REPRODUCTION IN PART OR AS A WHOLE WITHOUT THE WRITTEN PERMISSION OF <INSERT COMPANY NAME HERE> IS PROHIBITED.

		UNLESS OTHERWISE SPECIFIED:	NAME	DATE
		DIMENSIONS ARE IN INCHES	DRAWN	
		TOLERANCES:	CHECKED	
		FRACTIONAL ±	ENG APPR.	
		ANGULAR: MACH ± BEND ±	MFG APPR.	
		TWO PLACE DECIMAL ±	Q.A.	
		THREE PLACE DECIMAL ±	COMMENTS:	
		INTERPRET GEOMETRIC TOLERANCING PER:		
		MATERIAL		
		FINISH		
NEXT ASSY	USED ON			
APPLICATION	DO NOT SCALE DRAWING			

ALUMINUM 0.0635"		
TITLE:		
GDC0-4WLSR-20LED-MN-WF-14-35K		
SIZE	DWG. NO.	REV
A		
SCALE: 1:5	WEIGHT:	SHEET 6 OF 10

TABS WELDED ON THE OUTSIDE OF FRAME BRACKET

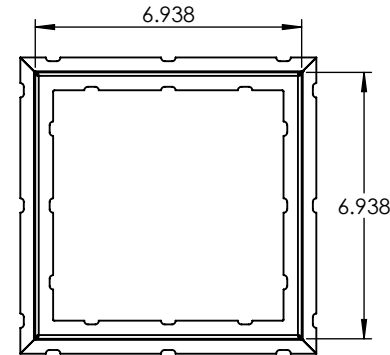
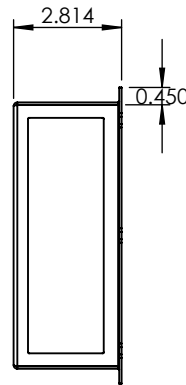
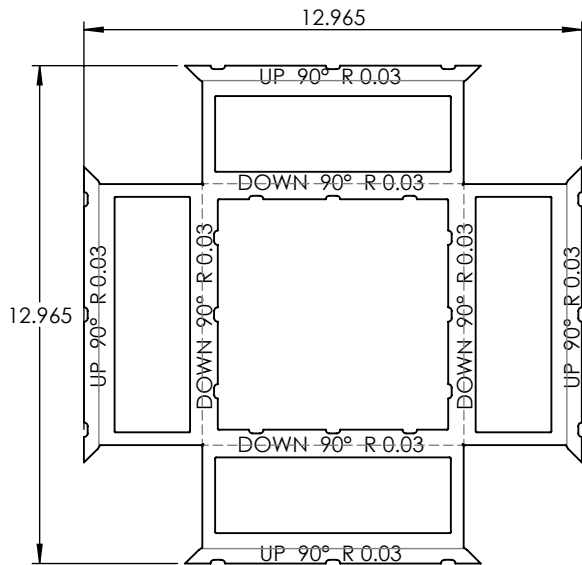
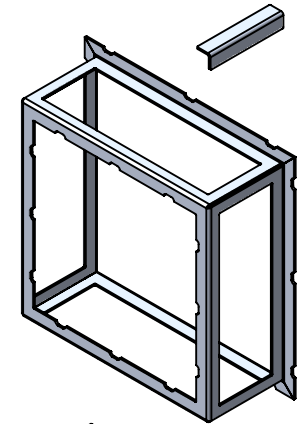
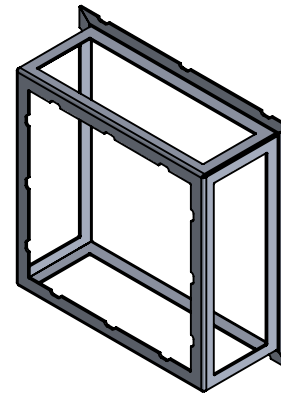
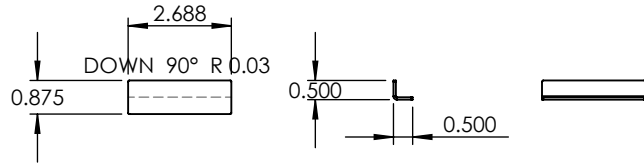

UNLESS OTHERWISE SPECIFIED:		NAME	DATE	ALUMINUM 0.0635"	
DIMENSIONS ARE IN INCHES TOLERANCES: FRACTIONAL ± ANGULAR: MACH ± BEND ± TWO PLACE DECIMAL ± THREE PLACE DECIMAL ±		DRAWN		TITLE:	
		CHECKED		GDC0-4WLSR-20LED-MN-WF-14-35K	
		ENG APPR.		SIZE DWG. NO. REV	
		MFG APPR.		A	
		Q.A.		SCALE: 1:5 WEIGHT: SHEET 7 OF 10	
		COMMENTS:			
INTERPRET GEOMETRIC TOLERANCING PER:					
MATERIAL					
FINISH					
NEXT ASSY	USED ON				
APPLICATION		DO NOT SCALE DRAWING			

PROPRIETARY AND CONFIDENTIAL
THE INFORMATION CONTAINED IN THIS DRAWING IS THE SOLE PROPERTY OF <INSERT COMPANY NAME HERE>. ANY REPRODUCTION IN PART OR AS A WHOLE WITHOUT THE WRITTEN PERMISSION OF <INSERT COMPANY NAME HERE> IS PROHIBITED.

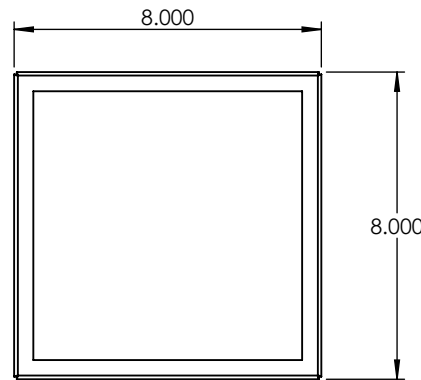
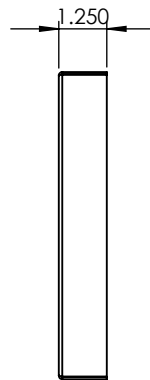
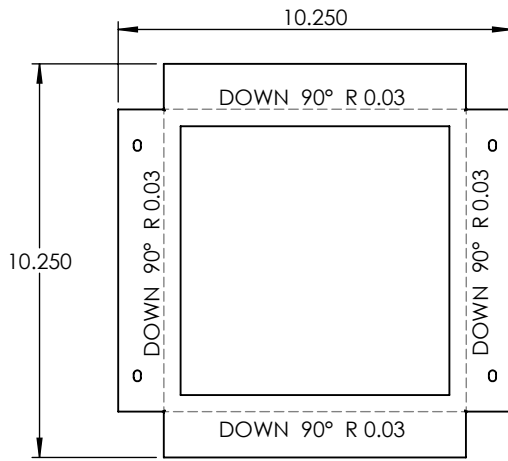
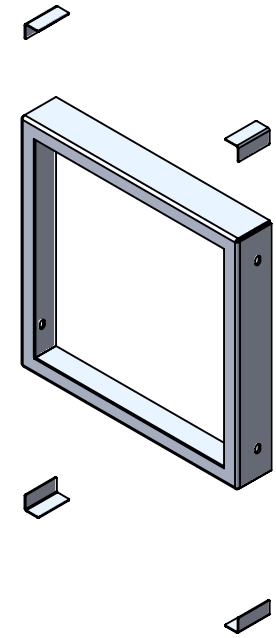
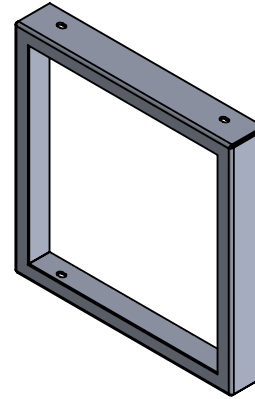
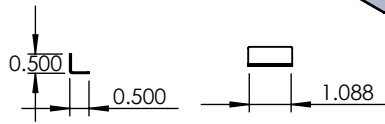
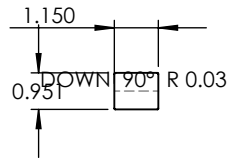

PROPRIETARY AND CONFIDENTIAL
 THE INFORMATION CONTAINED IN THIS DRAWING IS THE SOLE PROPERTY OF <INSERT COMPANY NAME HERE>. ANY REPRODUCTION IN PART OR AS A WHOLE WITHOUT THE WRITTEN PERMISSION OF <INSERT COMPANY NAME HERE> IS PROHIBITED.

		UNLESS OTHERWISE SPECIFIED:	NAME	DATE	ALUMINUM 0.0635"	
		DIMENSIONS ARE IN INCHES TOLERANCES: FRACTIONAL ± ANGULAR: MACH ± BEND ± TWO PLACE DECIMAL ± THREE PLACE DECIMAL ±	DRAWN		TITLE:	
		INTERPRET GEOMETRIC TOLERANCING PER:	CHECKED		GDC0-4WLSR-20LED-MN-WF-14-35K	
		MATERIAL	ENG APPR.		SIZE	DWG. NO.
		FINISH	MFG APPR.		A	REV
NEXT ASSY	USED ON	APPLICATION	Q.A.	COMMENTS:	SCALE: 1:5	WEIGHT:
		DO NOT SCALE DRAWING			SHEET 8 OF 10	

5

4

3

2

1

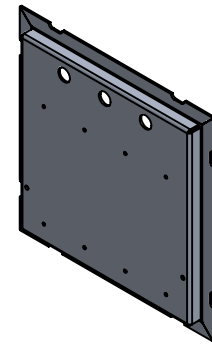
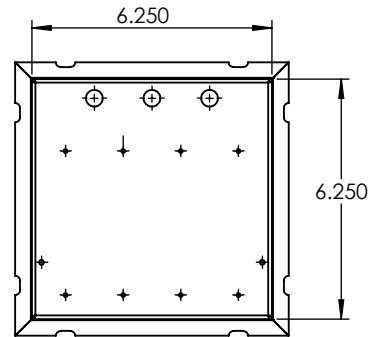
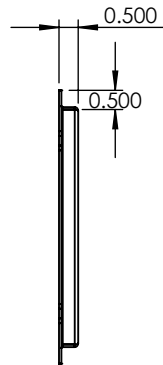
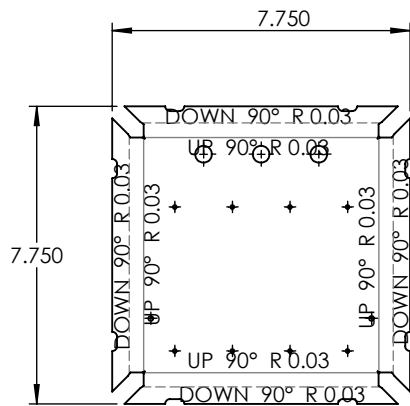
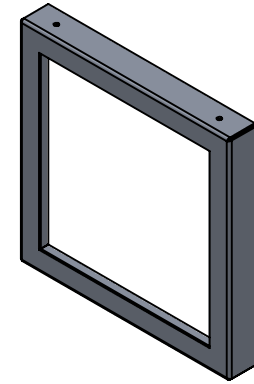
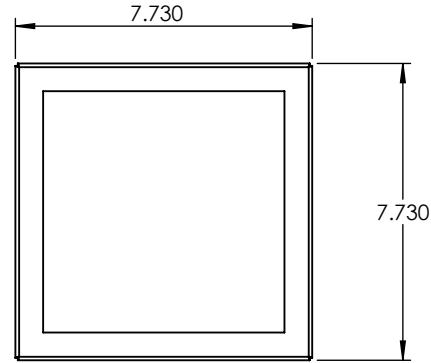
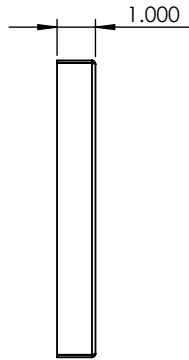
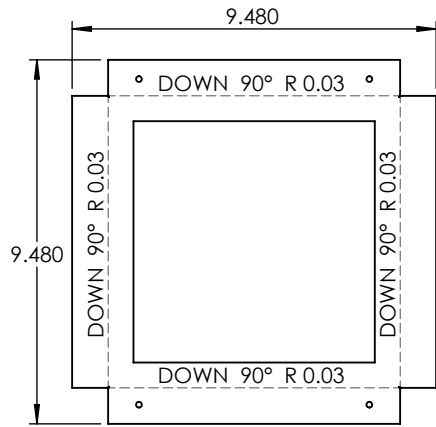

PROPRIETARY AND CONFIDENTIAL
 THE INFORMATION CONTAINED IN THIS DRAWING IS THE SOLE PROPERTY OF <INSERT COMPANY NAME HERE>. ANY REPRODUCTION IN PART OR AS A WHOLE WITHOUT THE WRITTEN PERMISSION OF <INSERT COMPANY NAME HERE> IS PROHIBITED.

NEXT ASSY	USED ON
APPLICATION	

UNLESS OTHERWISE SPECIFIED:
DIMENSIONS ARE IN INCHES
TOLERANCES:
FRACTIONAL ±
ANGULAR: MACH ± BEND ±
TWO PLACE DECIMAL ±
THREE PLACE DECIMAL ±
INTERPRET GEOMETRIC TOLERANCING PER:
MATERIAL
FINISH
DO NOT SCALE DRAWING

	NAME	DATE
DRAWN		
CHECKED		
ENG APPR.		
MFG APPR.		
Q.A.		
COMMENTS:		

ALUMINUM 0.0635"		
TITLE:		
GDC0-4WLSR-20LED-MN-WF-14-35K		
SIZE	DWG. NO.	REV
A		
SCALE: 1:5	WEIGHT:	SHEET 9 OF 10

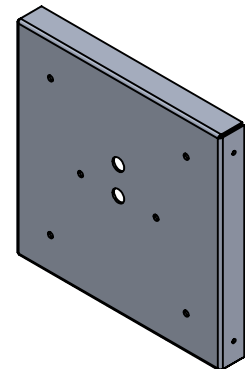
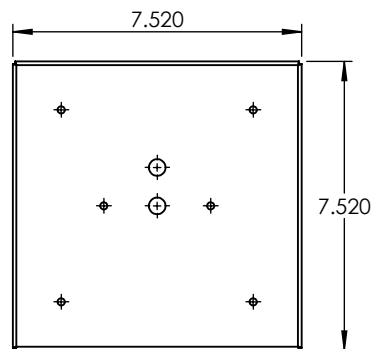
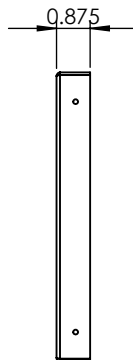
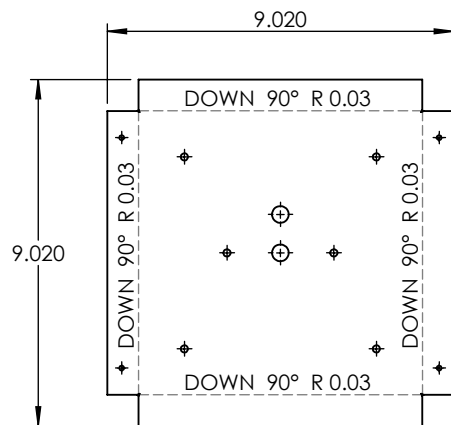

PROPRIETARY AND CONFIDENTIAL
 THE INFORMATION CONTAINED IN THIS DRAWING IS THE SOLE PROPERTY OF <INSERT COMPANY NAME HERE>. ANY REPRODUCTION IN PART OR AS A WHOLE WITHOUT THE WRITTEN PERMISSION OF <INSERT COMPANY NAME HERE> IS PROHIBITED.

NEXT ASSY	USED ON
APPLICATION	

UNLESS OTHERWISE SPECIFIED:
DIMENSIONS ARE IN INCHES
TOLERANCES:
FRACTIONAL ±
ANGULAR: MACH ± BEND ±
TWO PLACE DECIMAL ±
THREE PLACE DECIMAL ±
INTERPRET GEOMETRIC TOLERANCING PER:
MATERIAL
FINISH
DO NOT SCALE DRAWING

NAME	DATE
DRAWN	
CHECKED	
ENG APPR.	
MFG APPR.	
Q.A.	
COMMENTS:	

ALUMINUM 0.0635"		
TITLE:		
GDC0-4WLSR-20LED-MN-WF-14-35K		
SIZE	DWG. NO.	REV
A		
SCALE: 1:5	WEIGHT:	SHEET 10 OF 10