

#DA BC "	D5FHBI A 69F	89G7 F-DHC B	E HM 7I H
%	F9! @\$56!<C!7 GA !H6@' \$m8-A !' \$?!657?D@H9	&&: 51; 9	%
&	F9! @\$56!<C!7 GA !H6@' \$m8-A !' \$?!: F9D@H9	&&: 51; 9	%
'	F9! @\$56!<C!7 GA !H6@' \$m8-A !' \$?!@BGF5-@	&&: 51; 9	&
(F9! @\$56!<C!7 GA !H6@' \$m8-A !' \$?!9B8 75D	&&: 51; 9	&
)	F9! @\$56!<C!7 GA !H6@' \$m8-A !' \$?!5@ A-BIA 65F	%#&""GEI 5F95@ A-BIA 65F	%
*	F9! @\$56!<C!7 GA !H6@' \$m8-A !' \$?!57FM@7	57FM@7	%
+	57 8) 78+\$5HE @98 8FJ 9F	8FJ 9F	&
,	5HU @98 DB%\$+6!%8GG	@98	(

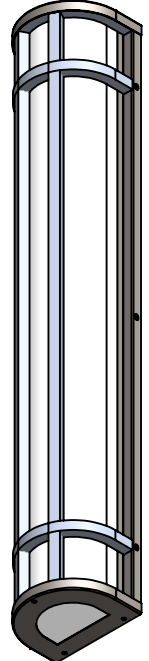

I B @9GC H: 9FK 69 GD97 ÷ 98.	B5A 9	85H9	
8-A 9BG@BG5F9-B-B7<9G HC @F5B7 9G : F57 HC B5@± "\$\$" 5B: I @F: A 57 < ± "\$\$""69B8 ± HK C D@579897-A 5@± "\$\$" H:F99D@579897-A 5@± "\$\$"	8F5K B		H#@.
BH@FDF9H: 9CA 9FF 7 HC @F5B7 B: D9F. A 5H@F5@	E "5"		F9! @\$56!<C!7 GA !H6@' \$m8-A !' \$?
: B @-	7 C A A 9BHG		G#9 8K; ""BC"
5 @69B8 F58 G "\$' \$"			5 H7 ?9H&' ' +,
5DD@7 5HC B	8C BCHG75@98F5K B:		G7 5 @. %, K 9 ÷ < H'
			G<99H% C: '*

) (' & %

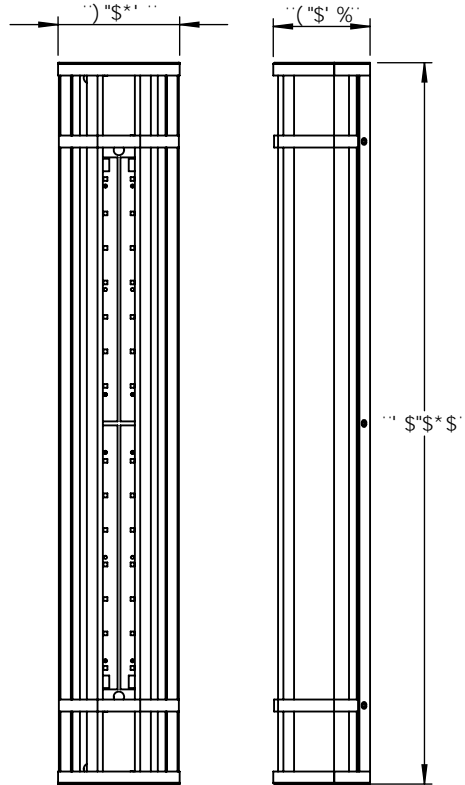
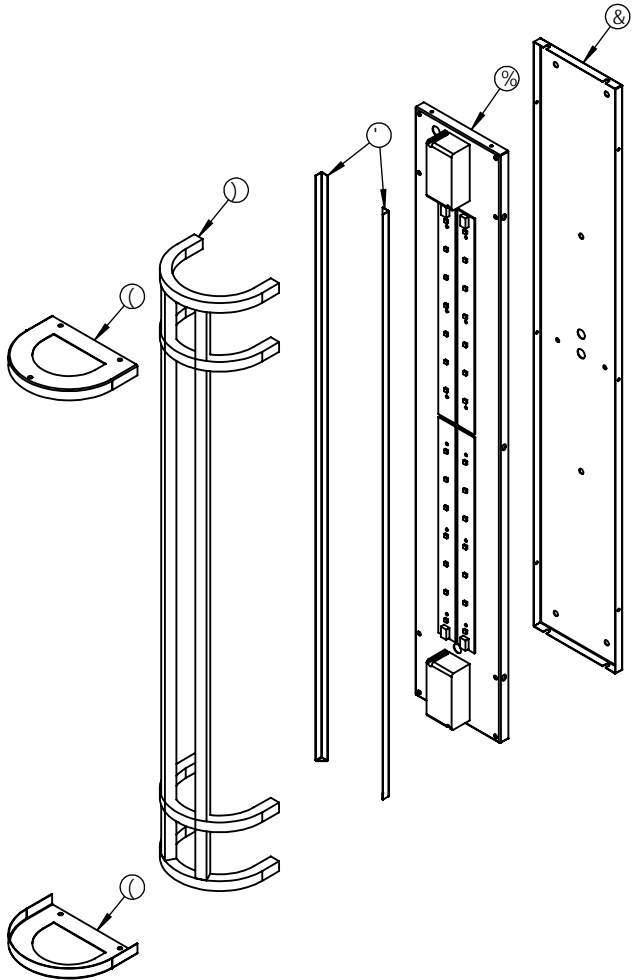
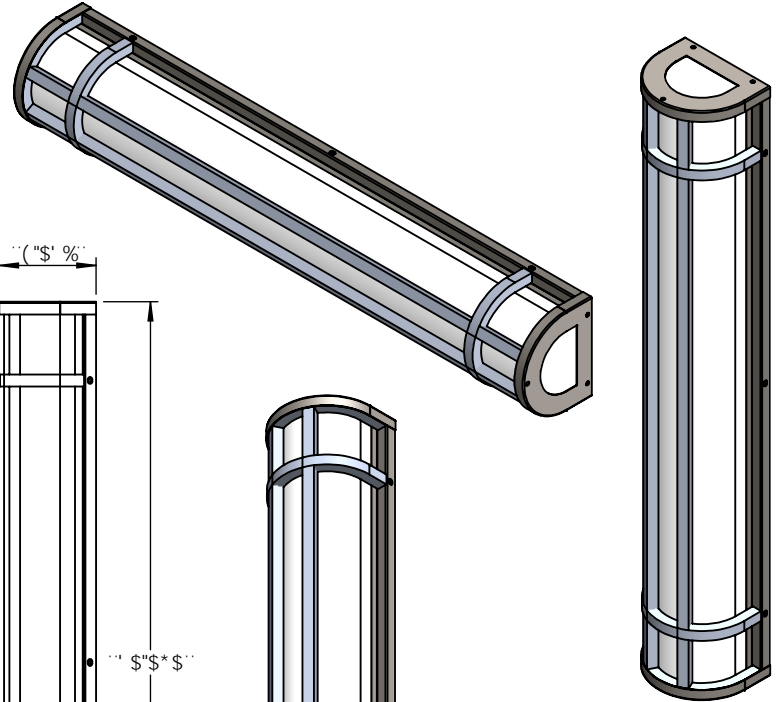
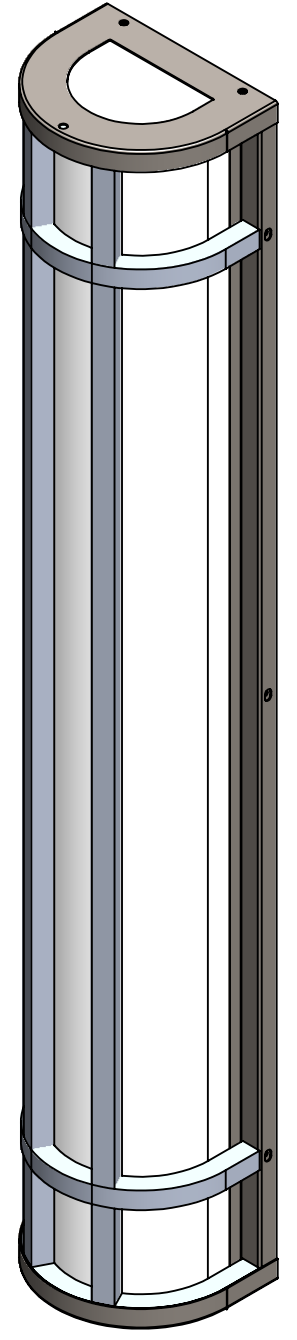
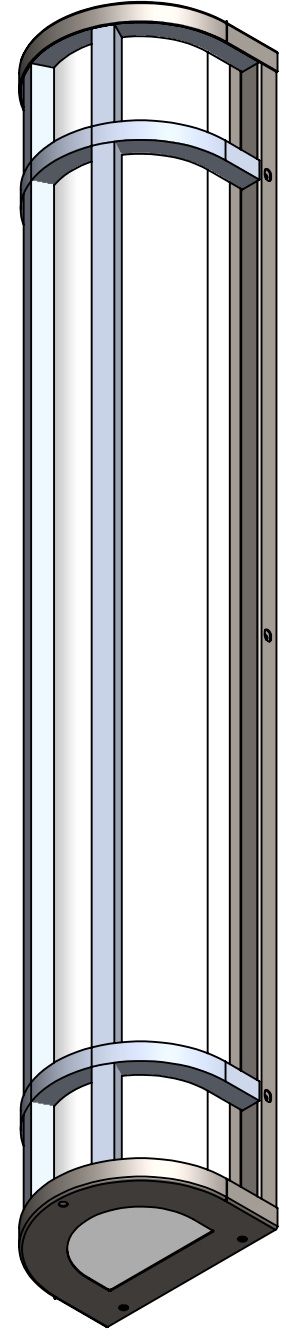
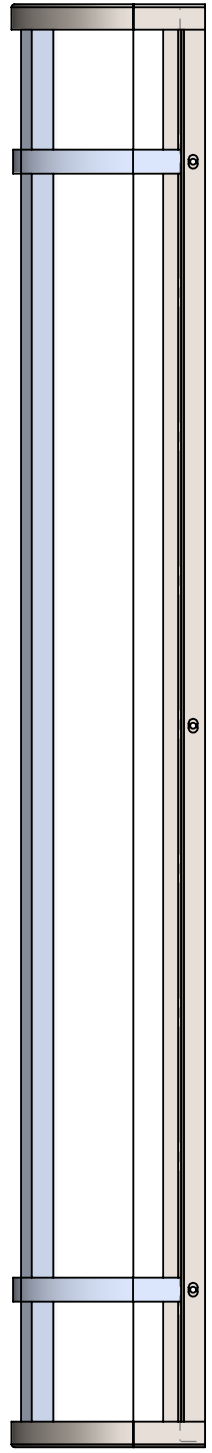
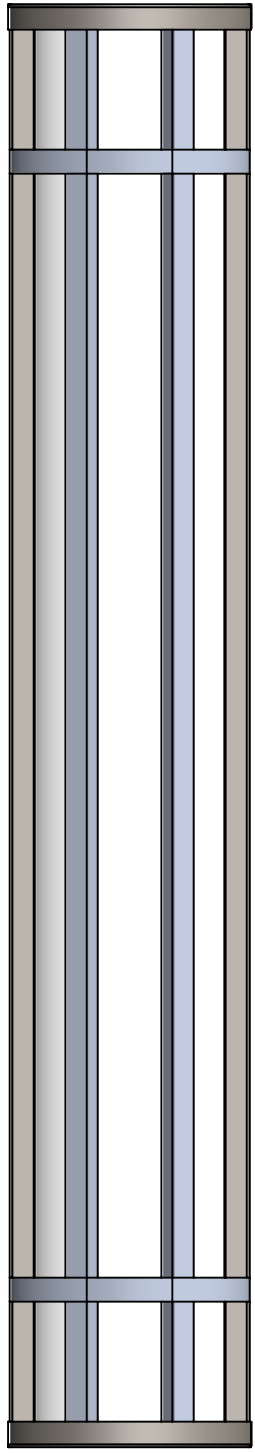

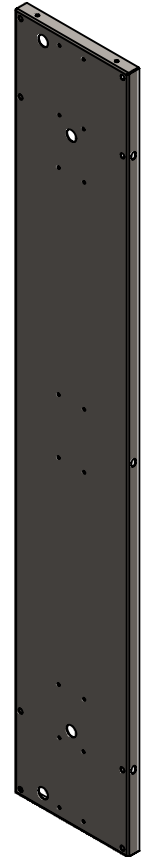
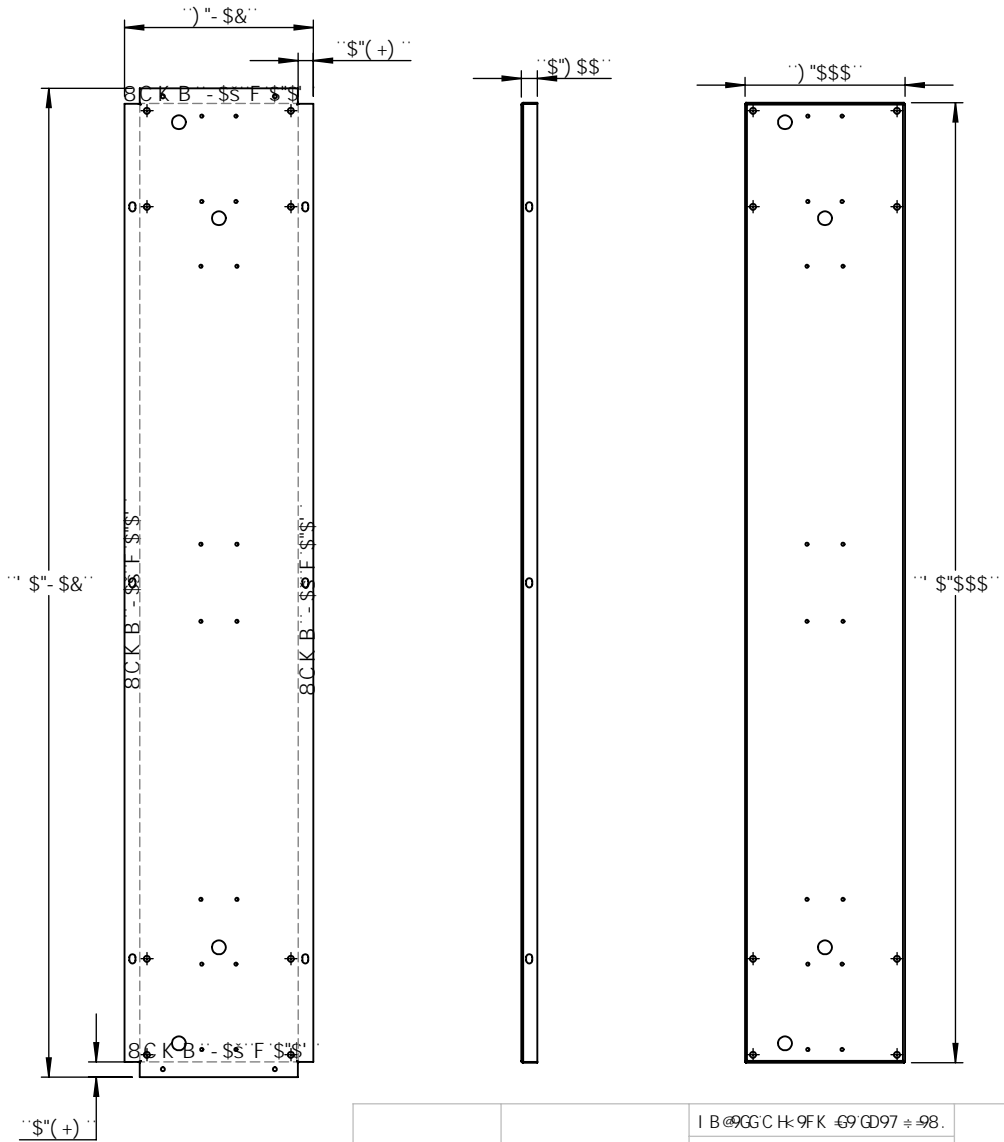

DFC DF 5 FM 5 B 8 7 C B : 8 9 B H 5 @
 H: 9 B: C F A 5 H C B 7 C B H 5 B 9 8 B H: 6
 8 F 5 K B: 6 H: 9 G C @ D F C D 9 F H V C:
 O B G 9 F H 7 C A D 5 B M B 5 A 9 < 9 F 9 2 " 5 B M
 F 9 D F C 8 1 7 H C B B D 5 F H C F 5 G 5 K < C @
 K H: C 1 H H: 9 K F H 9 B D 9 F A G G C B C:
 O B G 9 F H 7 C A D 5 B M B 5 A 9 < 9 F 9 2 G
 D F C < 6 H 9 8 "

		I B @ G G C H: 9 F K @ 9 G D 9 7 ≠ 9 8.		B 5 A 9	8 5 H 9	& ; 5 1 ; 9		
		8 A 9 B G C B G 5 F 9 B B 7 < 9 G H C @ F 5 B 7 9 G : F 5 7 H C B 5 @ ± 5 B: 1 @ 5 F: A 5 7 < ± 6 9 8 8 ± H K C D @ 5 7 9 8 9 7 A 5 @ ± ± H: F 9 9 D @ 5 7 9 8 9 7 A 5 @ ±	8 F 5 K B 7 < 9 7 ? 9 8					H # @.
		B H 9 F D F 9 H: 9 C A 9 F 7 H C @ F 5 B 7 B: D 9 F. A 5 H 9 F 5 @	9 B: 5 D D F" A: : 5 D D F"			F 9 ! \$ @ 5 6 ! < C ! 7 G A ! H @ ' \$ f f i 8 A ! ' \$?		
	B 9 L H 5 G G M	I G 9 8 C B	: B G <	E " 5" 7 C A A 9 B H G		G A 9 5	8 K ; " " B C "	F 9 J
	5 D D @ 7 5 H C B	8 C B C H G 7 5 @ 9 8 F 5 K B:				G 7 5 @ . % * K 9 ÷ < H'		G < 9 9 H' ' C : * %

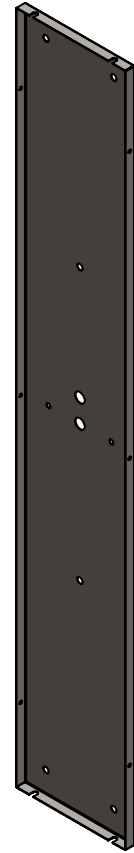
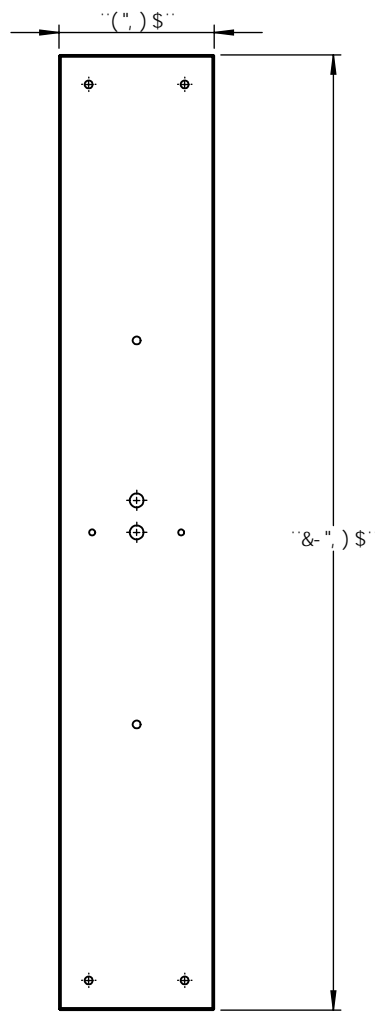
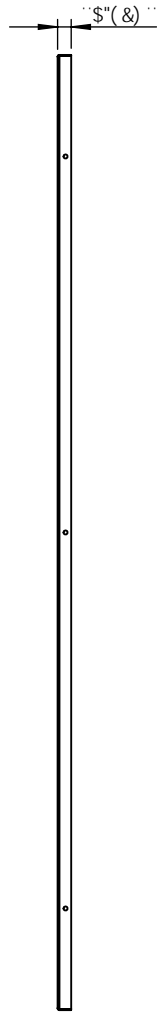
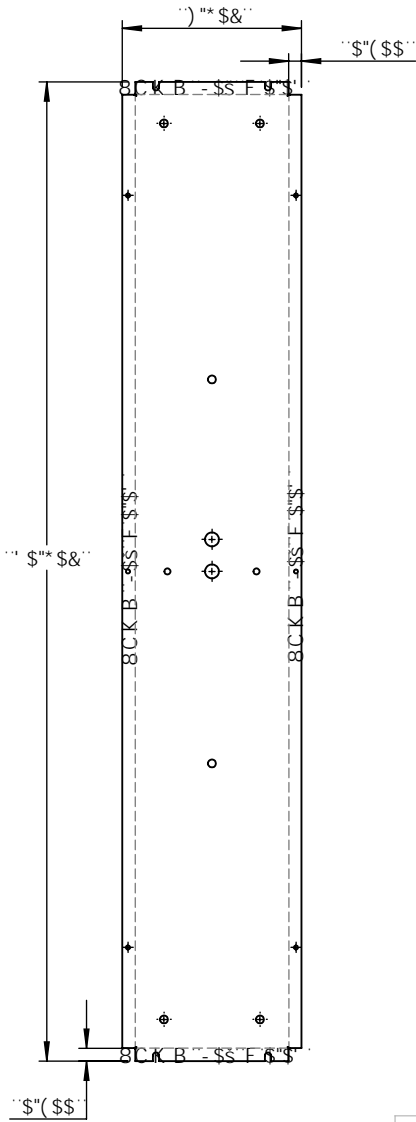

DFC DF 5FM5B87CB: 89BH5@
 H:9 B: CFA 5HC B 7C B15 B98 B H:6
 8F5K B: 6H:9GC @DFC D9FHVC:
 OB9FH7CA D5BMB5A 9<9F92\" 5BM
 F9DFC 817HC B B D5FHCF 5G5 K <C @
 K H:C1 H:9K F H9B D9FA 6GC B C:
 O:BG9FH7CA D5BMB5A 9<9F92 6
 DFC <6H98*

		I B @GGCH:9FK 69GD97 ÷ 98.		B5A 9	85H9	&&; 51; 9		
		8A 9BGCG5F9 B B7 <9G HC @F5B7 9G ;F57HC B5@± 5B; 1 @5F: A 57 <±69B8 ± HK C D@579897 A 5@± H:KF99D@579897 A 5@±	8F5K B 7 <97 ?98 9B; 5DDF" A:; 5DDF"					H#@.
		BH9DF9H: 9CA 9FF 7 HC @F5B7 B: D9F. A 5H9F 5@	E "5" 7CA A 9BHG			F9! \$@56! <C!7GA !H6@! \$m8 A ! ?		
	B9LH5GGM	I G98 CB	: B<			G#9 5	8K; ""BC"	F9J
	5DD@7 5HC B	8C BCHG75@98F5K B:				G75 @. %* K 9 ÷ <H'		G<99H('C: '* %

)

(

&

%

1 D F S S F S S

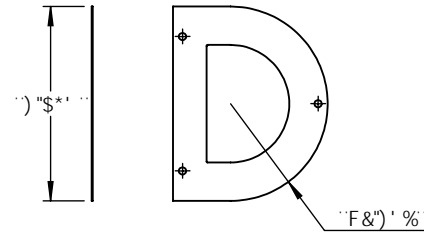
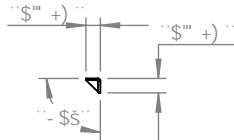

8- (&

8- %

DFC DF-96FM5B87CB: 89BH5@
 H-9-B: CFA 5HC B 7 C B H5 B 98 B H-6
 8F5K B: 6H-9GC @DFC D9FHMC:
 OB 9FH7 CA D5BMB5A 9<9F92" 5BM
 F9DFC 81 7 HC B -B D5FHCF 5G5 K <C @
 K H-C1 Hk 9K F H9B D9FA 6GC B C:
 OB 9FH7 CA D5BMB5A 9<9F92 6
 DFC <6H98"

		I B @GGCH: 9FK 69 GD97 ÷ 98.	B5A 9	85H9	&&; 5I; 9
		8-A 9BG€BG5F9-B B7<9G HC @F5B7 9G ;F57 HC B5@± 5B; I @5F: A 57 <±.....69B8' ± HK C D@57 9897 A 5@'± HkF99D@57 9897 A 5@±	8F5K B		
		BH9DF9H: 9CA 9FF 7 HC @F5B7 B: D9F.	7<97?98		F9! \$@56!<C!7 GA !H6@! \$m!8 A !' \$?
		A 5H9F 5@	9B: 5DDF"		
		A 5H9F 5@	A:: 5DDF"		GAP 8K; ""BC" F9J
		: B<	E "5"		
B9LH5GGM	I G98 CB		7 C A A 9BHG		G7 5 @. %) K 9 ÷ <H' G<99H) 'C: '*
	5DD@7 5HC B	8C BCHG75@98F5K B:			

) (' & %

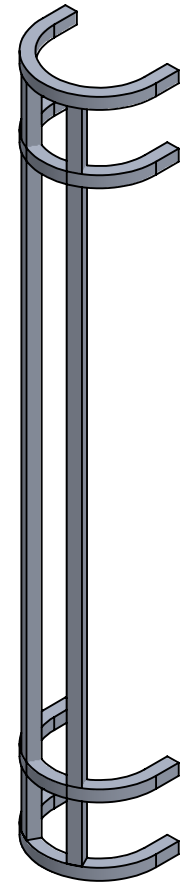
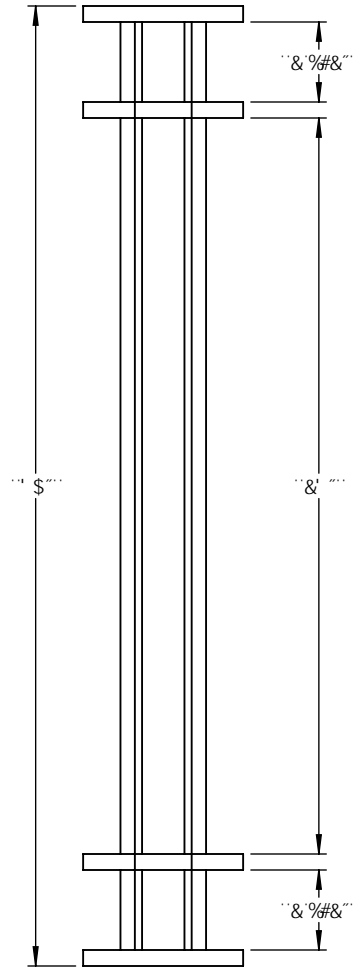
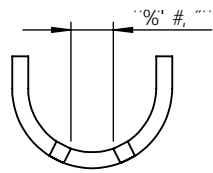
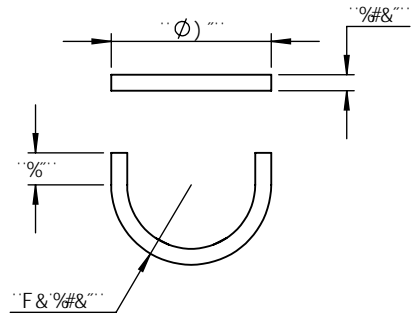

DFC DF-5FM5B87CB: 89BH5@
 H:9 B: CFA 5HC B 7 C B H5 B 98 B H:6
 8F5K B: 6H:9 GC @DFC D9FHMC:
 OBG9FH7 CA D5BMB5A 9<9F92" 5BM
 F9DFC 81 7 HC B B D5FHCF 5G5 K <C @
 K H:C I H:9 K F H9B D9FA 6GC B C:
 OBG9FH7 CA D5BMB5A 9<9F92 6
 DFC <6#98"

		I B @GGCH:9FK 69GD97 ÷ 98.	B5A 9	85H9	%#&"GE I 5F9'5@ A B I A '65F
		8 A 9BG@BG5F9 B B7 <9G HC @F5B7 9G : F57 HC B5 @± 5B: I @5F: A 57 <± "69B8 ± HK C D@57 9897 A 5@± H: F99D@57 9897 A 5@±	8F5K B		H#@.
			7 <97 ?98		F9! \$@56!<C!7 GA !H@' \$ffi8 A !' \$?
			9B: 5DDF"		
			A: 5DDF"		
		BH9DF9H: 9CA 9FF 7 HC @F5B7 B: D9F.	E "5"		
		A 5H9F 5@	7 C A A 9BHG		
B9LH5GGM	I G98 C B	: B<			G#9 8K; "'BC" F9J
	5DD@7 5HC B	8C B CHG75@8F5K B:			G7 5 @. %* K 9 ÷ <H' G<99H* C: *

)

(

&

%