

#9A BC*	D5FHBI A 69F	8 9G7 F-DHC B	E HM 71 H
%	J 9F ( &%%@5 6!K :!(%? !HC D < 9L5 : C B	&& : 51 : 9	%
'	J 9F ( &%%@5 6!K :!(%? !HC D 71 F J 9	&& : 51 : 9	%&
(	J 9F &&\$-!&A 98!5 6!5!K 9H7 9BHF 71 F J 9	&& : 51 : 9	%&
)	J 9F ( &%%@5 6!K :!(%? !: F5 A 9H 6G	&& : 51 : 9	*
*	J 9F ( &%%@5 6!K :!(%? !8 C C F	&& : 51 : 9	%
+	J 9F ( &%%@5 6!K :!(%? !D 5H 6F 57 9H	&& : 51 : 9	&
-	J 9F ( &%%@5 6!K :!(%? !F 9. @7 HC F D 5H	&& : 51 : 9	%
.	J 9F ( &%%@5 6!K :!(%? !H 69 6F 57 9H	&& : 51 : 9	%
%\$	J 9F ( &%%@5 6!K :!(%? !6C HC A < 9L5 : C B	% : 51 : 9	%
%&	J 9F ( &%%@5 6!K :!(%? !57 FM 7	57 FM 7	+
%&	J 9F ( &%%@5 6!K :!(%? !CE I 5F 9H 69	% GE I 5F 95 @ A -B I A H 69	%
%	DC GH: HBF	DC GH: HBF	%
%{	"+) m!6F 5GG:1 @65 @	6F 5GG	%
%	9gd YbH7 <S&&\$&+J SG71 , \$, \$+*	8F J 9F	&
%	5 TU @98 SDB %\$&SFY I 9	@98	(

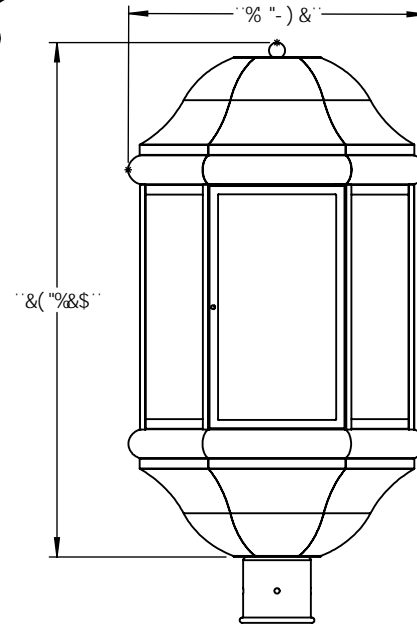

I B @GGC H: 9FK 69 GD97 ÷ 98.	B5A 9	85H9	
8-A 9BGC BG5F9-B-B7 < 9G HC @F 5B7 9G : F57 HC B5 @± "\$\$" 5B: I @F: A 57 < ± "\$\$"" 69B 8 ± HK C D @5 7 9 8 97-A 5 @"" ± H:F 99 D @5 7 9 8 97-A 5 @ ± "\$\$%	8F5K B	7 < 97 ? 98	H# @.
BHFD 9H: 9C A 9F 7 HC @F 5B7 B: D9F. A 5HF 5 @	E "5"	7 C A A 9BHG	J 9F ( &%%@5 6!K :!(%?
: B 6<			G# 9 8K ; ""BC"
5 @69B8 F58 ÷ G" \$' \$"			<b>5</b> H7 ? 9H &' ) \$-
5DD @7 5HC B	8C BCHG 7 5 @9 8F5K B:		G7 5 @. %- K 9 ÷ < H'
			G < 99H %C : ;

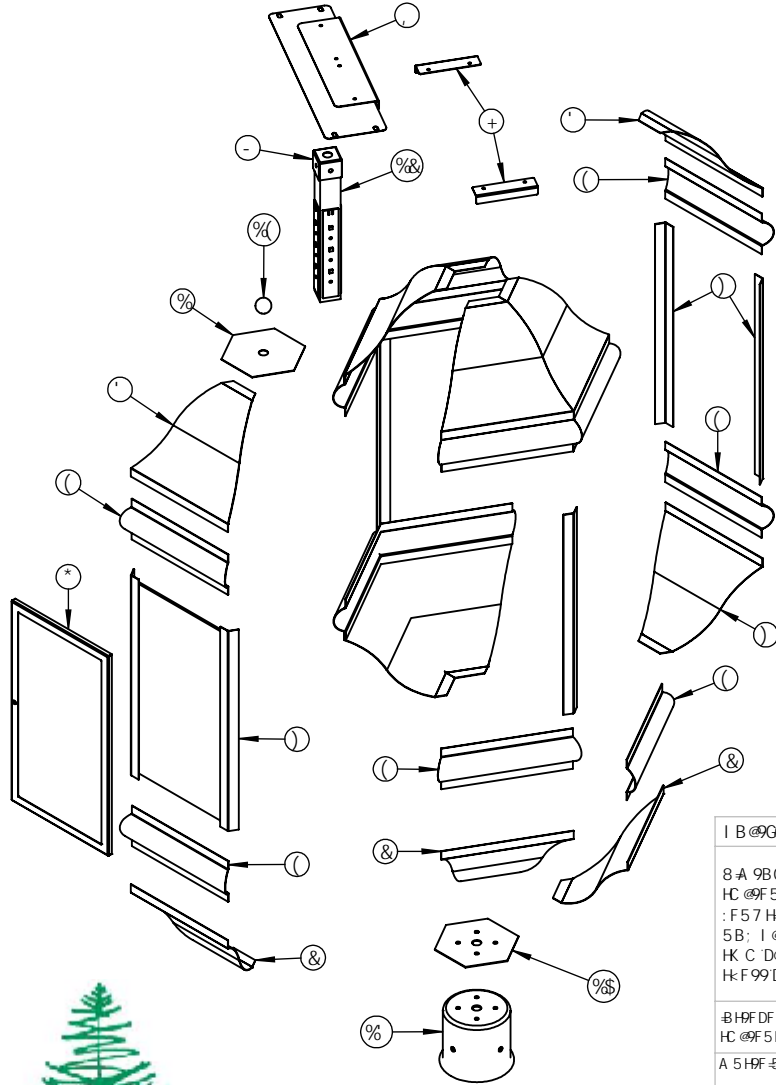

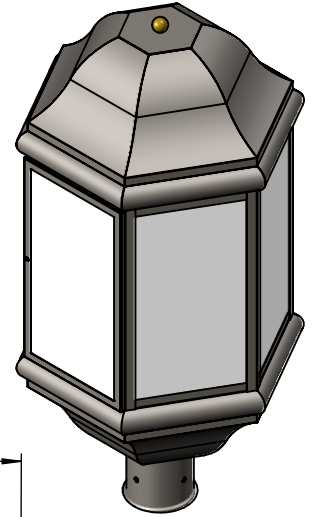
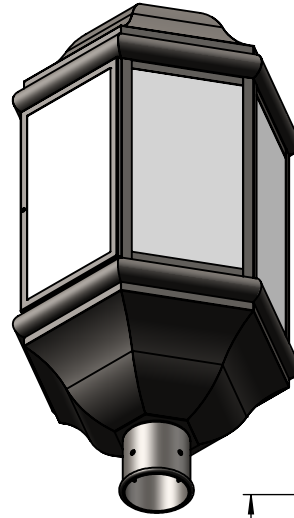
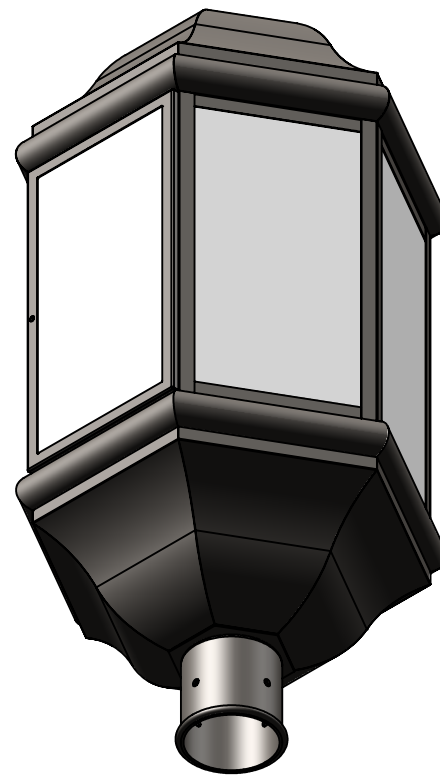
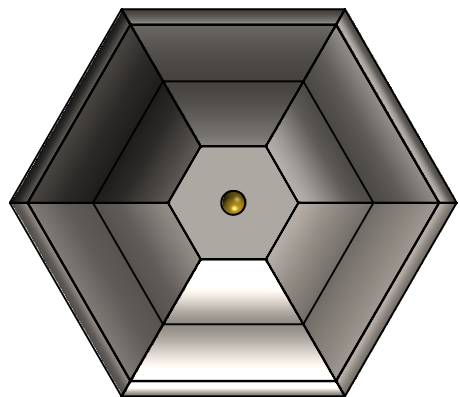
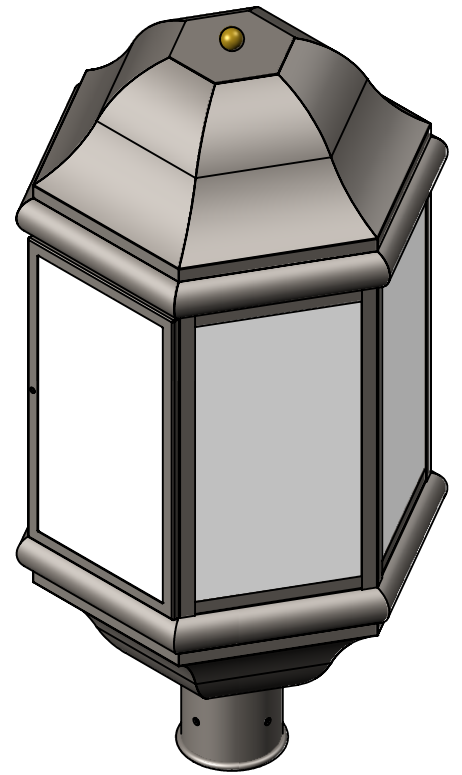
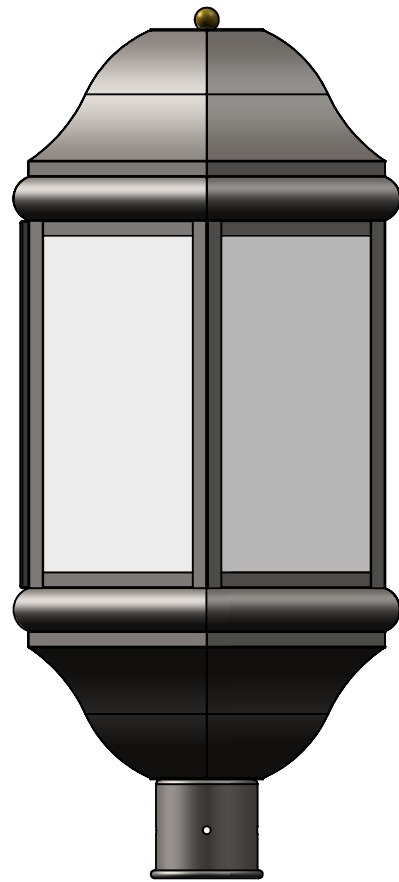
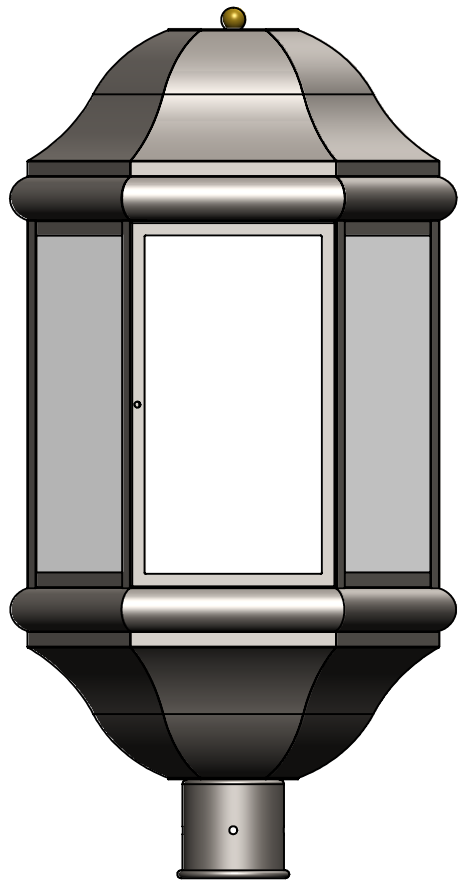
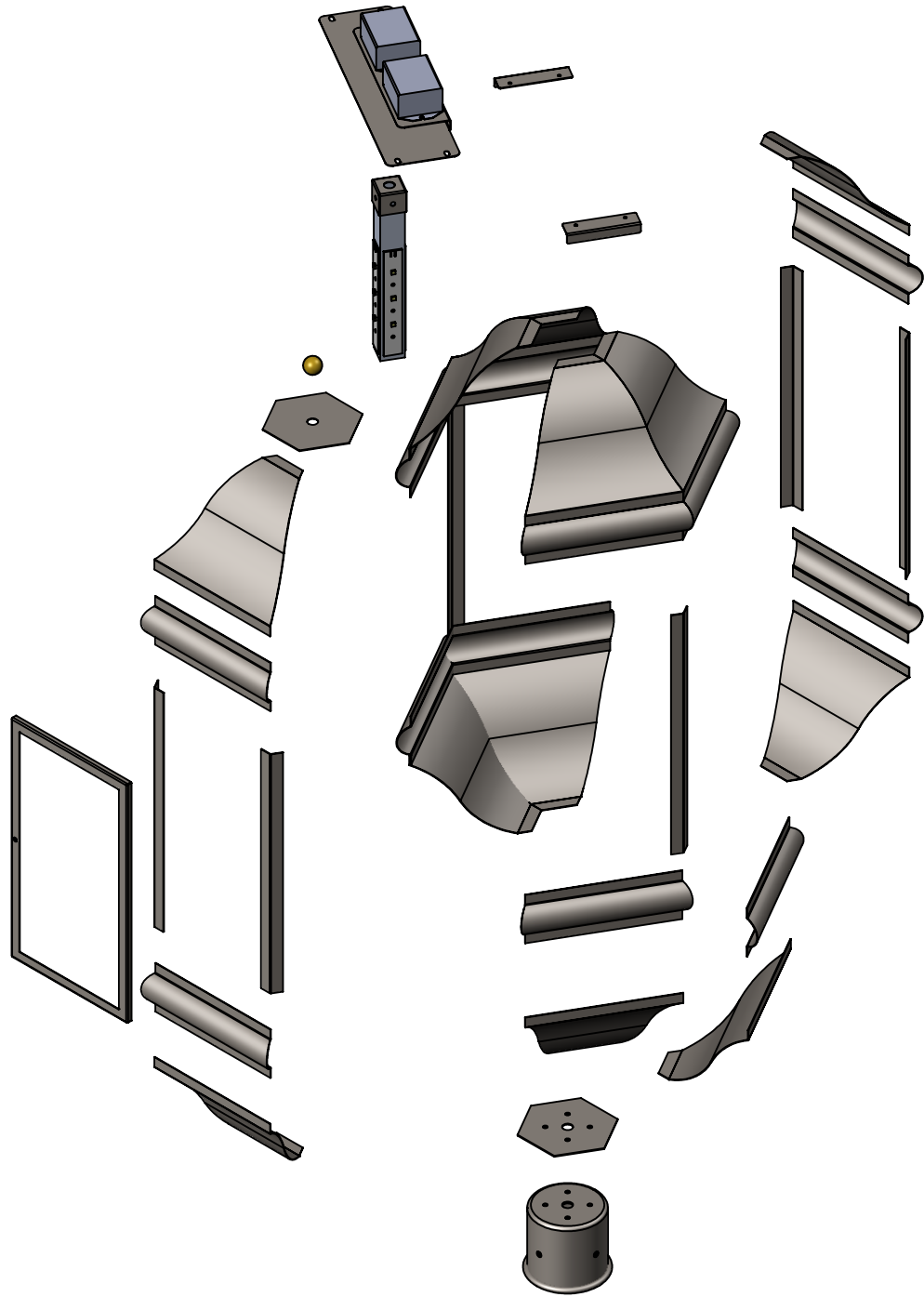

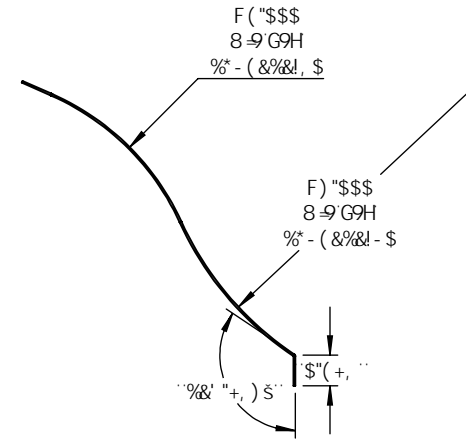
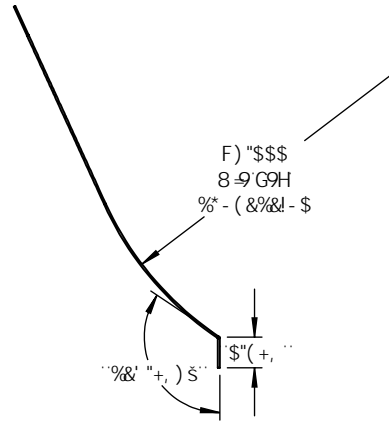
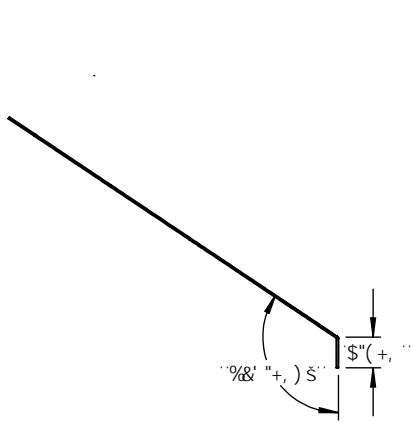
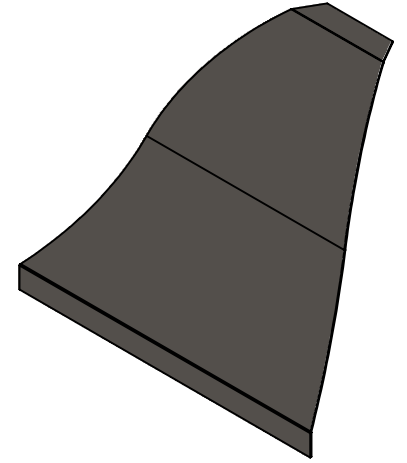
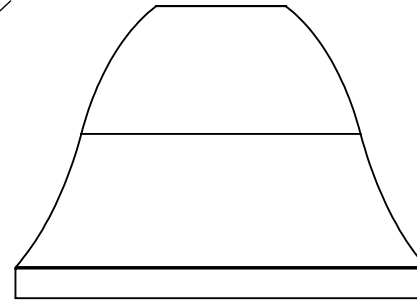
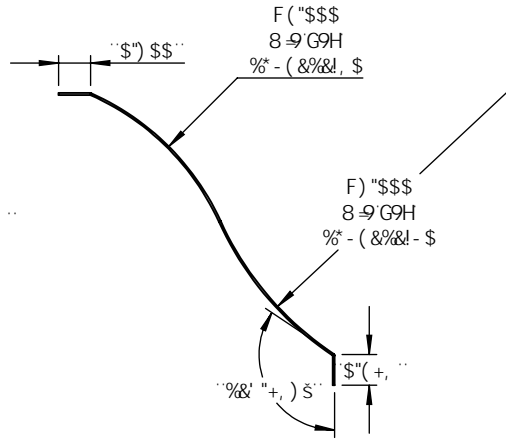
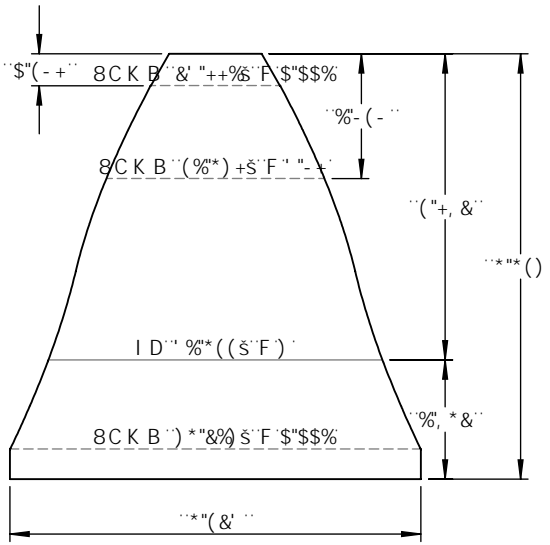

DFC DF 5FM5B87CB: 89BH5@  
 H:9 B: CFA 5HC B 7C BH5 B98 B H:6  
 8F5K B: 6H:9GC @DFC D9F HVC:  
 OBG9FH7CA D5BMB5A 9<9F92" 5BM  
 F9DFC 817HC B-B D5FHCF 5G5 K <C @  
 K H:C1 H:K 9K F H9B D9FA 6GC B C:  
 OBG9FH7CA D5BMB5A 9<9F92 6  
 DFC <6#98"

		I B @GGC H:9FK 69GD97 ÷ 98.	B5A 9	85H9	&&; 51; 9		
		8A 9BGC BG5F9 B B7 <9G HC @F5B7 9G :F57 HC B5@± 5B: I @F: A 57 <±.....69B8 ± HK C D@579897 A 5@±± H:KF99D@579897 A 5@±	8F5K B			H#@.	
		BH9FDF9H: 9CA 9FF 7 HC @F5B7 B: D9F.	9B: 5DDF"		J 9F( &%@56!K :!(%?		
		A 5H9F 5@	A: 5DDF"				
B9LH5GGM	I G98 CB	:B 6<	E "5"		GAP 8K; "BC"	F9J	
5DD@7 5HC B	8C BCHG75@98F5K B:		7CA A 9BHG		G75 @. %'	K 9÷ <H'	G<99H('C: ;

)

(

&

%

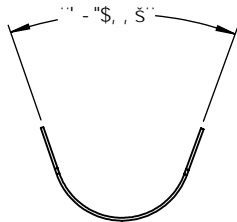
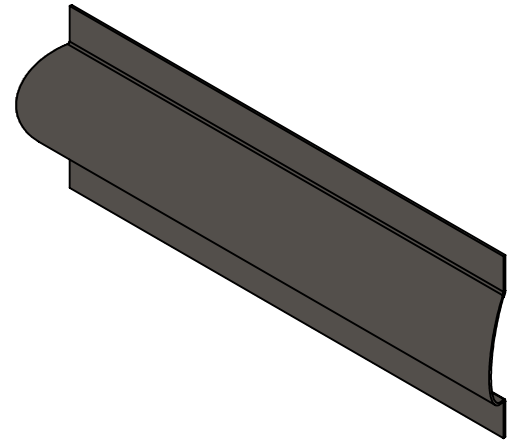
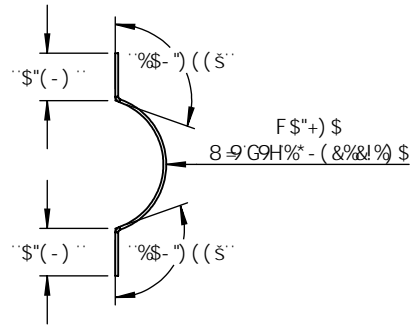
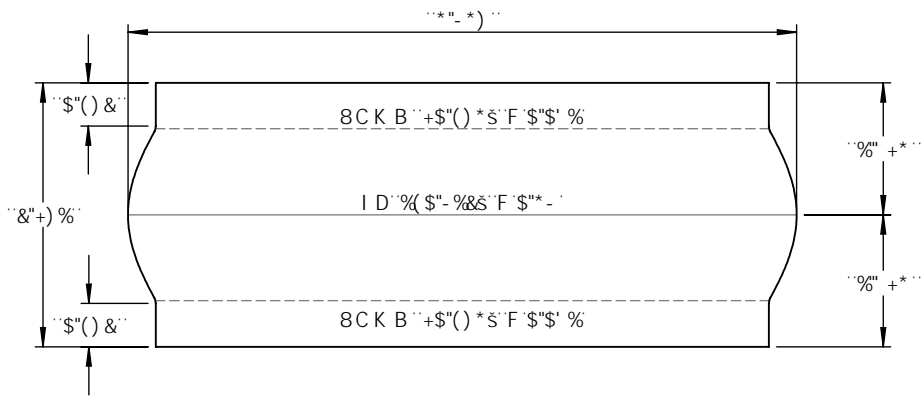

F\$'+)\$  
8-9'G9H%' - (&%&!%) \$

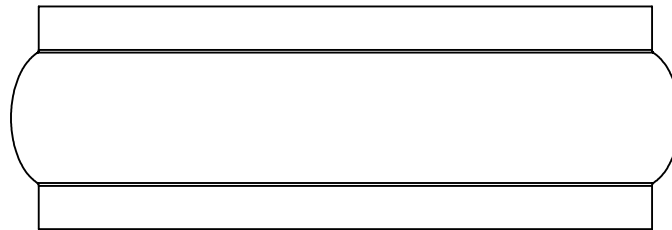

DFC DF-9F5FM5B87CB: 89BH5@  
H:9 B: CFA 5HC B 7C B15 B98 B H:6  
8F5K B: 6H:9GC @DFC D9F HVC:  
OBG9FH7CA D5BMB5A 9<9F92" 5BM  
F9DFC 817HC B-B D5FHCF 5G5'K <C @  
K H:C1 H:9K F H9B D9FA 6GC B C:  
OBG9FH7CA D5BMB5A 9<9F92 6  
DFC <6#98\*

		I B @GGCH:9FK 69GD97 ÷ 98.		B5A 9	85H9	&&; 51; 9		
		8A 9BG@BG5F9-B B7 <9G HC @F5B7 9G :F57 HC B5@± 5B: I @5F: A 57 <±.....69B8 ± HK C D@579897 A 5@± H:F99D@579897 A 5@±	8F5K B 7 <97 ?98 9B: 5DDF" A: 5DDF"					J 9F (&%&@56!K :!(%?
		BH9DF9H: 9CA 9FF 7 HC @F5B7 B: D9F. A 5H9F 5@	E "5" 7CA A 9BHG			G#9 <b>5</b>	8K; "'BC"	
	B9LH5GGM	I G98 CB	:B 6<			G75 @. %&	K 9÷ <H'	G<99H) 'C: ;
	5DD@7 5HC B	8C BCHG75 @98F5K B:						

)

(

&

%

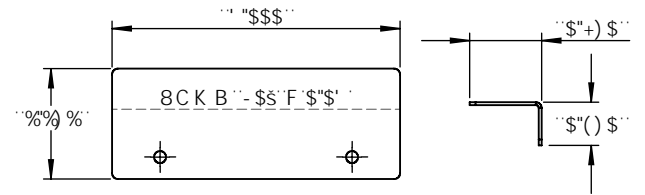
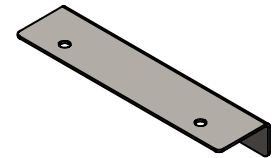
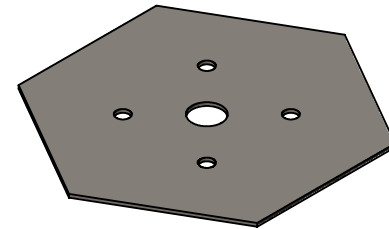
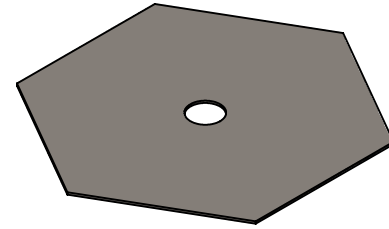
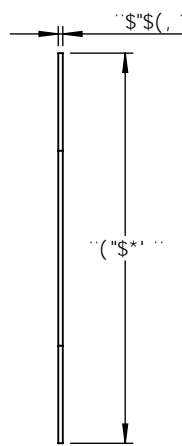
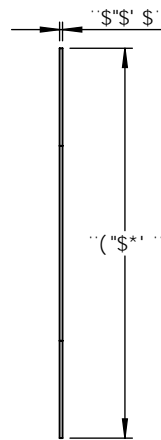
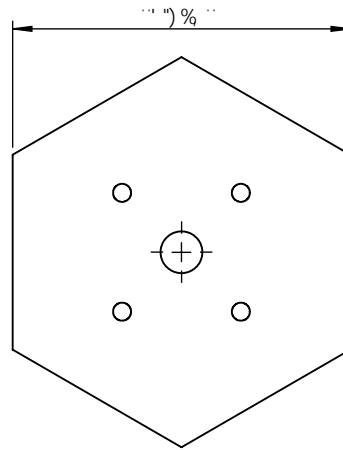
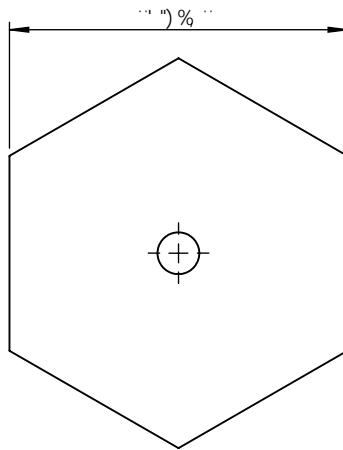
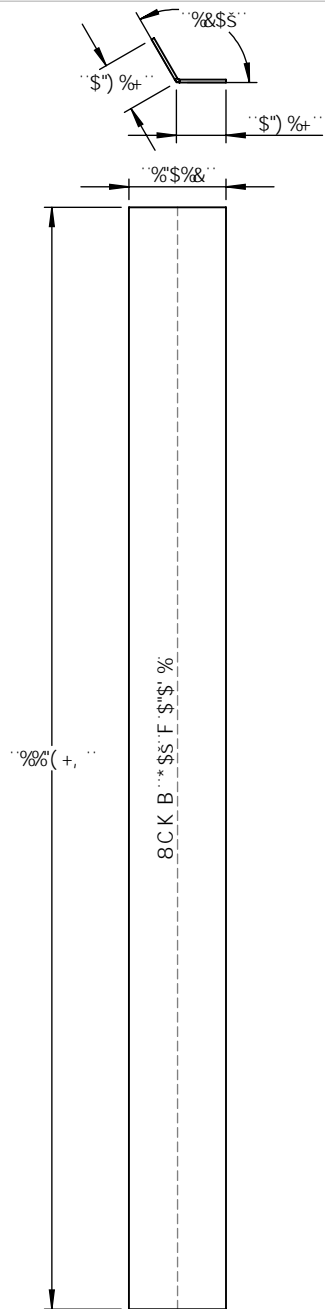

DFC DF 5 FM 5 B 8 7 C B : 8 9 B H 5 @  
 H : 9 B : C F A 5 H C B 7 C B H 5 B 9 8 B H : 6  
 8 F 5 K B : 6 H : 9 G C @ D F C D 9 F H V C :  
 O B G 9 F H 7 C A D 5 B M B 5 A 9 < 9 F 9 2 " 5 B M  
 F 9 D F C 8 1 7 H C B B D 5 F H C F 5 G 5 K < C @  
 K H : C 1 H H : 9 K F H 9 B D 9 F A 6 G C B C :  
 O B G 9 F H 7 C A D 5 B M B 5 A 9 < 9 F 9 2 G  
 D F C < 6 H 9 8 "

		I B @ G G C H : 9 F K 6 9 G D 9 7 ÷ 9 8 .	B 5 A 9	8 5 H 9
		8 A 9 B G C B G 5 F 9 B B 7 < 9 G H C @ F 5 B 7 9 G : F 5 7 H C B 5 @ ± 5 B : I @ F : A 5 7 < ± ..... 6 9 B 8 ± H K C D @ 5 7 9 8 9 7 A 5 @ ± ± H : F 9 9 D @ 5 7 9 8 9 7 A 5 @ ±	8 F 5 K B	7 < 9 7 9 8
		B H 9 F D F 9 H : 9 C A 9 F F 7 H C @ F 5 B 7 B : D 9 F .	9 B : 5 D D F "	A : : 5 D D F "
		A 5 H 9 F 5 @	E " 5 "	7 C A A 9 B H G
B 9 L H 5 G G M	I G 9 8 C B	: B 6 <		
5 D D @ 7 5 H C B		8 C B C H G 7 5 @ 9 8 F 5 K B :		

&& ; 5 1 ; 9		
H # @ .		
J 9 F ( & % @ 5 6 ! K : ! ( % ?		
G A 9	8 K ; " " B C "	F 9 J
5		
G 7 5 @ . % &	K 9 ÷ < H "	G < 9 9 H * " C : ;

)

(

&

%

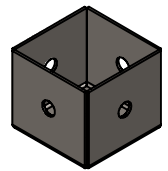
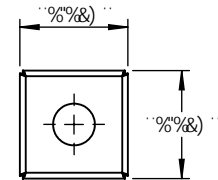
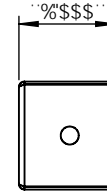
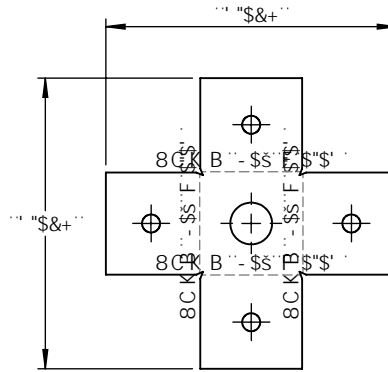
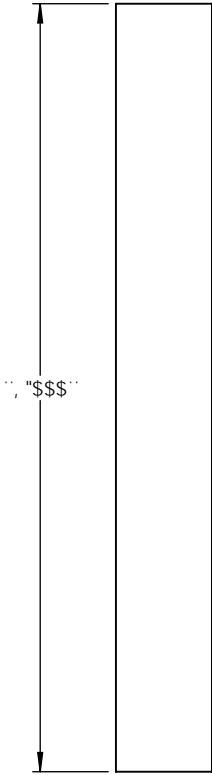
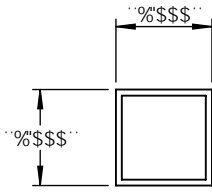

DFC DF 5 FM 5 B 8 7 C B : 8 9 B H 5 @  
 H: 9 B: C F A 5 H C B 7 C B H 5 B 9 8 B H: 6  
 8 F 5 K B: 6 H: 9 G C @ D F C D 9 F H M C:  
 O B G 9 F H 7 C A D 5 B M B 5 A 9 < 9 F 9 2 " 5 B M  
 F 9 D F C 8 1 7 H C B B D 5 F H C F 5 G 5 K < C @  
 K H: C 1 H H: 9 K F H 9 B D 9 F A 6 G C B C:  
 O B G 9 F H 7 C A D 5 B M B 5 A 9 < 9 F 9 2 G  
 D F C < 6 H 9 8 "

		I B @ 9 G C H: 9 F K 6 9 G D 9 7 ÷ 9 8.	B 5 A 9	8 5 H 9	% " G E I 5 F 9 5 @ A B I A ' H 6 9 H # @.		
		8 A 9 B G C B G 5 F 9 B B 7 < 9 G H C @ F 5 B 7 9 G : F 5 7 H C B 5 @ ± 5 B: I @ 5 F: A 5 7 < ± ..... 6 9 B 8 ± H K C D @ 5 7 9 8 9 7 A 5 @ ± ± H: F 9 9 D @ 5 7 9 8 9 7 A 5 @ ±	8 F 5 K B			J 9 F ( & % @ 5 6 ! K : ! ( %	
		B H 9 F D F 9 H: 9 C A 9 F 7 H C @ F 5 B 7 B: D 9 F.	7 < 9 7 9 8				
		A 5 H 9 F 5 @	9 B: 5 D D F "				
		: B 6 <	A: : 5 D D F "				
B 9 L H 5 G G M	I 9 8 C B	8 C B C H G 7 5 @ 8 F 5 K B:	E " 5 "		G A 9 8 K ; " " B C "	F 9 J	
	5 D D @ 7 5 H C B		7 C A A 9 B H G		G 7 5 @ . % &	K 9 ÷ < H '	G < 9 9 H + ' C : ;

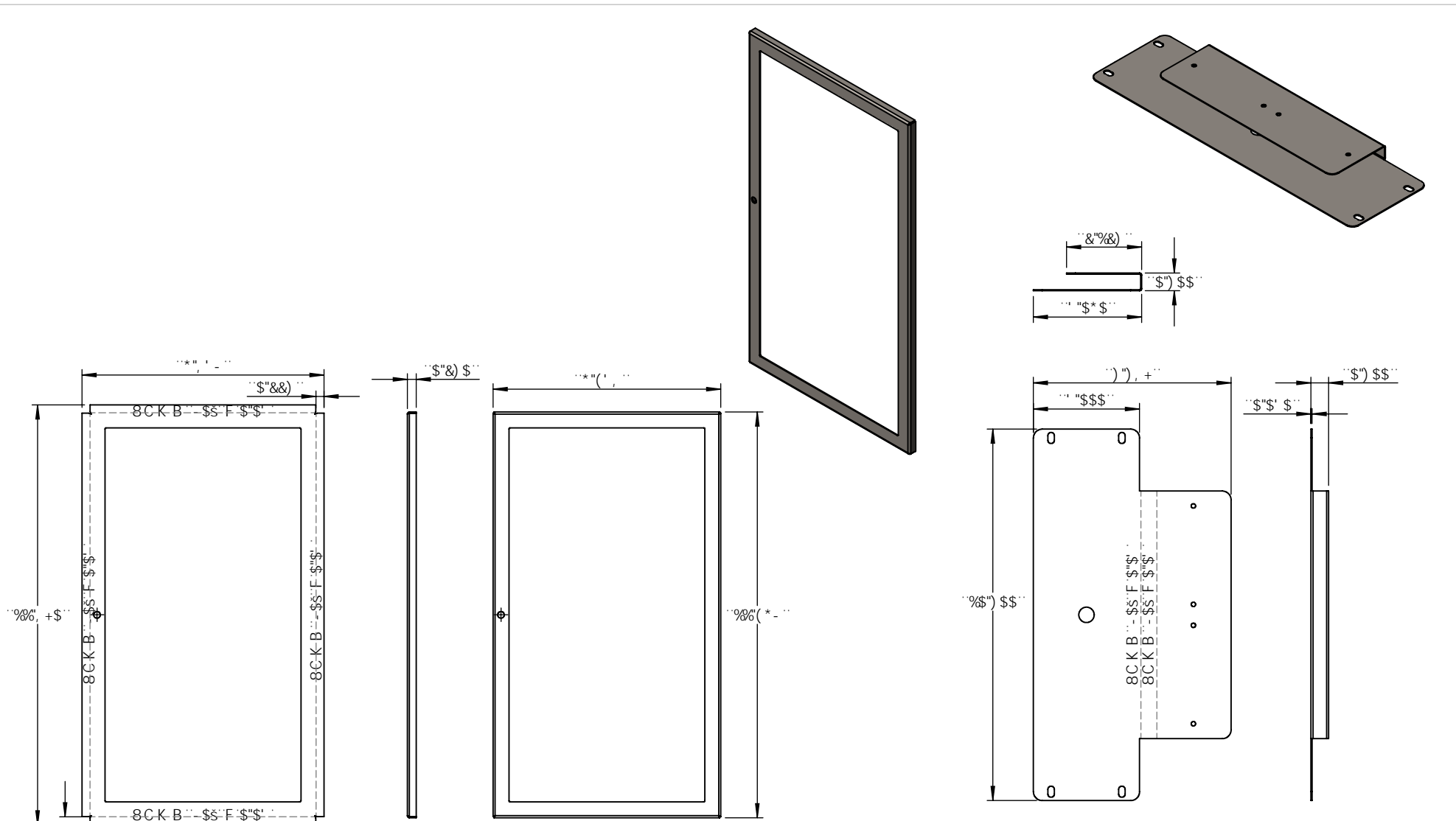

DFC DF 5FM5B87CB: 89BH5@  
 H:9 B: CFA 5HC B 7 C B H 5 B 98 B H:6  
 8F5K B: 6H:9 GC @DFC D9F HVC:  
 O:B G9FH7 CA D5BMB5A 9<9F92" 5BM  
 F9DFC 81 7 HC B B D5FHCF 5G5 K <C @  
 K H:C I H:9K F H9B D9FA 6GC B C:  
 O:B G9FH7 CA D5BMB5A 9<9F92 6  
 DFC <6#98\*

		I B @GGCH:9FK 69 GD97 ÷ 98.	B5A 9	85H9	&&; 51; 9	
		8 A 9BGC BG5F9 B B7 <9G HC @F5B7 9G ;F57 HC B5 @± 5B; I @F: A 57 <± .....69B8 ± HK C D@57 9897 A 5@± H:F99D@57 9897 A 5@±	8F5K B			H#@.
		B H9DFDF9H: 9C A 9F 7 HC @F5B7 B: D9F.	9B; 5DDF"		J 9F ( &@56!K :!(%?	
		A 5H9F 5@	A:; 5DDF"			
		:B 6<	E "5"			
			7 C A A 9BHG			
B9LH5GGM	I G98 C B				G#9 8K; "BC"	F9J
5DD@7 5HC B		8C B CHG75 @98F5K B:			G7 5 @.% ( K 9 ÷ <H'	G<99H, 'C: ;

)

(

&

%