

ITEM NO.	PART NUMBER	DESCRIPTION	QTY.	CUT
1	CE-W-15"-24W-SB-WF-PDIM-TBL-41K-BACKPLATE	22 GAUGE	1	
2	CE-W-15"-24W-SB-WF-PDIM-TBL-41K-SPUN BRACKET	22 GAUGE	2	
3	CE-W-15"-24W-SB-WF-PDIM-TBL-41K-SPUN CAP	SPUN 22 GAUGE	2	
4	CE-W-15"-24W-SB-WF-PDIM-TBL-41K-ALUMINUM BAR	1/2" SQUARE ALUMINUM BAR	2	
5	CE-W-15"-24W-SB-WF-PDIM-TBL-41K-ACRYLIC	ACRYLIC	1	
6	KEYSTONE KTLD-25-UV-700-AF4-CP	DRIVER	1	
7	AltILED_PN1004RevD	LED	4	

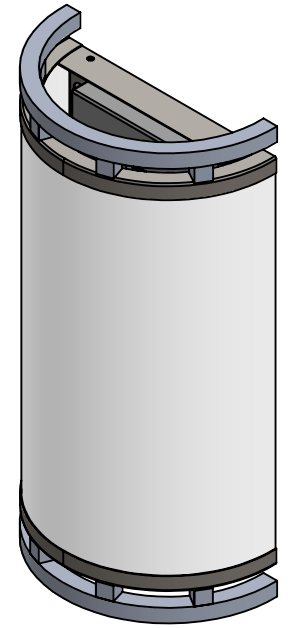
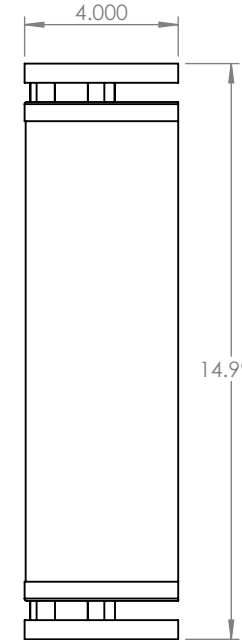
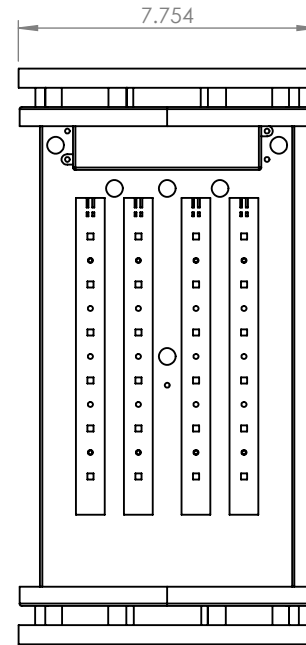
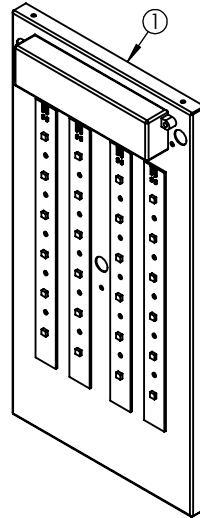
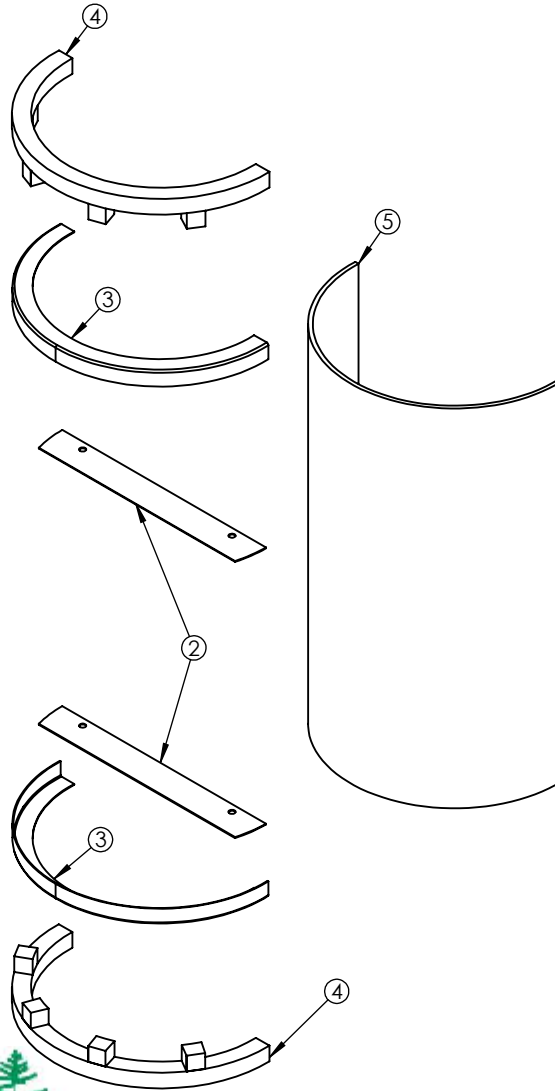

**EVERGREEN LIGHTING**

ALL BEND RADIUS .030"

APPLICATION

DO NOT SCALE DRAWING

UNLESS OTHERWISE SPECIFIED:

DIMENSIONS ARE IN INCHES  
 TOLERANCES:  
 FRACTIONAL ± .003  
 ANGULAR: MACH ± .01 BEND ±  
 TWO PLACE DECIMAL ±  
 THREE PLACE DECIMAL ±.001

INTERPRET GEOMETRIC  
 TOLERANCING PER:

MATERIAL

FINISH

NAME

DATE

DRAWN

CHECKED

ENG APPR.

MFG APPR.

Q.A.

COMMENTS:

TITLE:

CE-W-15"-24W-SB-WF-PDIM-TBL-41K

SIZE DWG. NO.

**A** TICKET 24500

REV

SCALE: 1:5

WEIGHT:

SHEET 1 OF 5

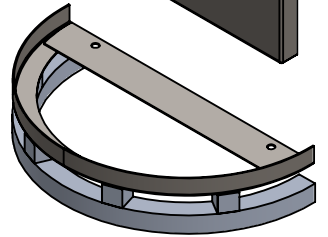
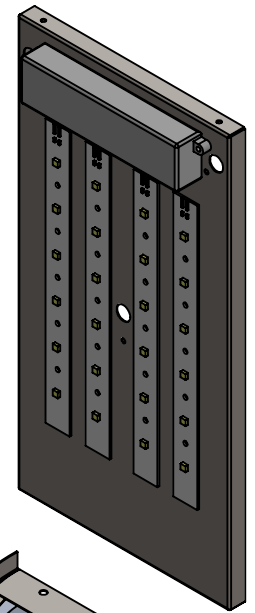
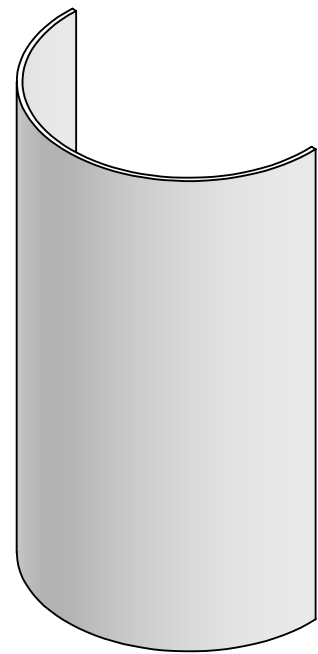
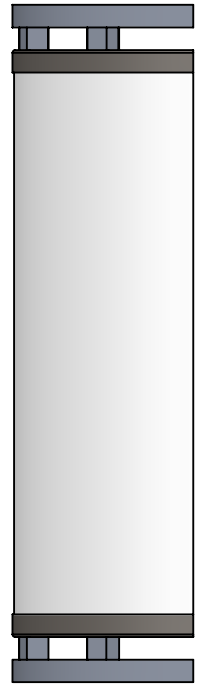
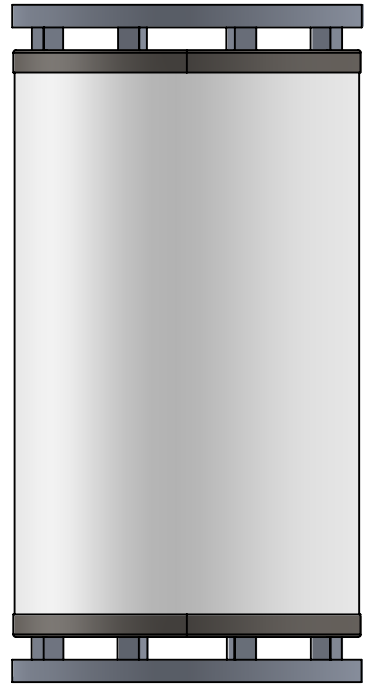
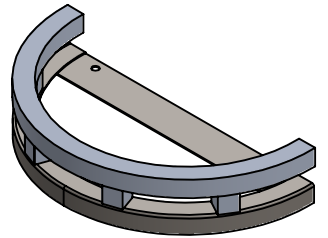
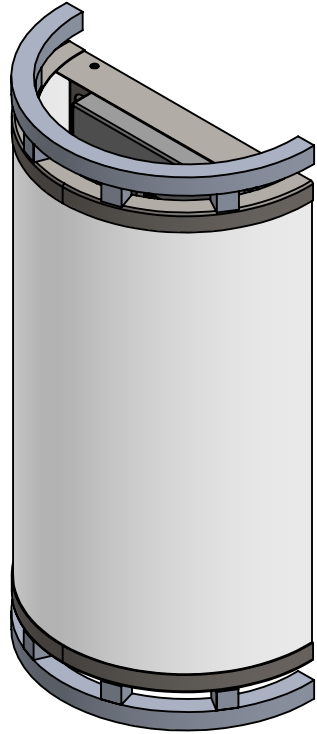

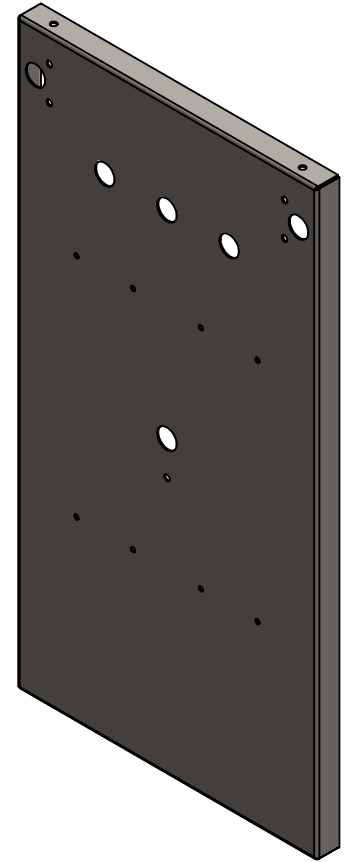
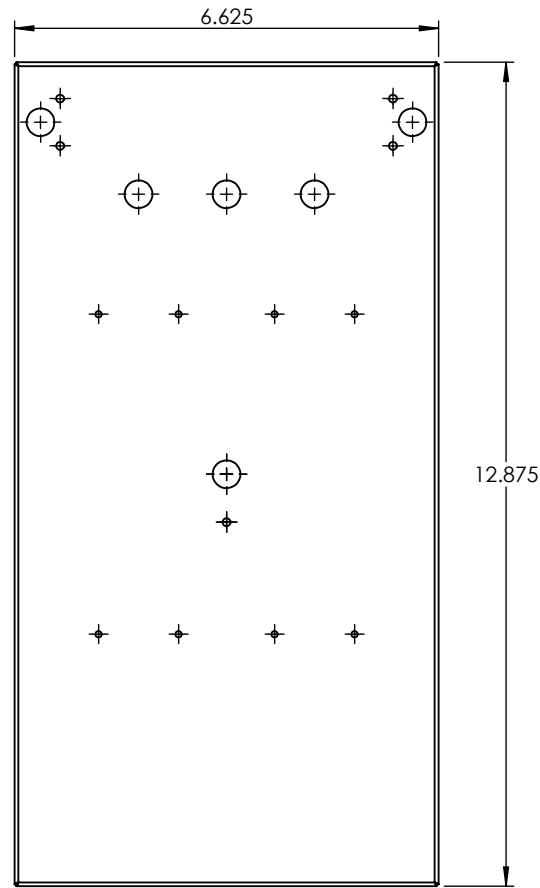
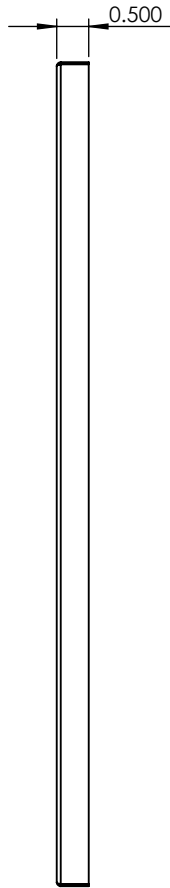
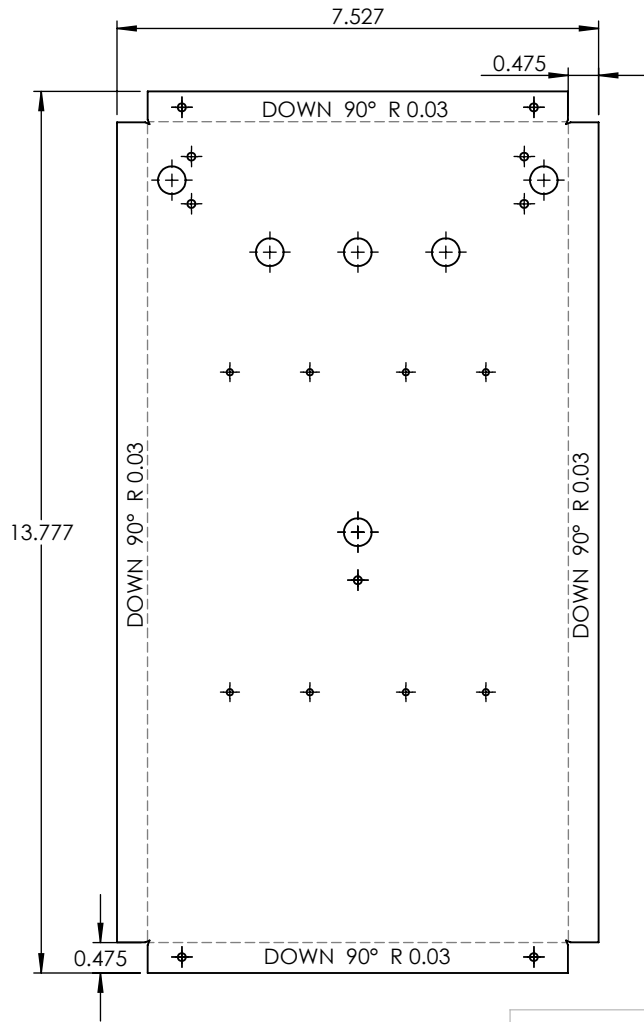

**PROPRIETARY AND CONFIDENTIAL**  
 THE INFORMATION CONTAINED IN THIS DRAWING IS THE SOLE PROPERTY OF <INSERT COMPANY NAME HERE>. ANY REPRODUCTION IN PART OR AS A WHOLE WITHOUT THE WRITTEN PERMISSION OF <INSERT COMPANY NAME HERE> IS PROHIBITED.

		UNLESS OTHERWISE SPECIFIED:	NAME	DATE
		DIMENSIONS ARE IN INCHES	DRAWN	
		TOLERANCES:	CHECKED	
		FRACTIONAL ±	ENG APPR.	
		ANGULAR: MACH ± BEND ±	MFG APPR.	
		TWO PLACE DECIMAL ±	Q.A.	
		THREE PLACE DECIMAL ±	COMMENTS:	
		INTERPRET GEOMETRIC TOLERANCING PER:		
		MATERIAL		
	NEXT ASSY	USED ON		
		FINISH		
	APPLICATION	DO NOT SCALE DRAWING		

22 GAUGE		
TITLE:		
CE-W-15"-24W-SB-WF-PDIM-TBL-41K		
SIZE	DWG. NO.	REV
<b>A</b>		
SCALE: 1:3	WEIGHT:	SHEET 3 OF 5

5

4

3

2

1

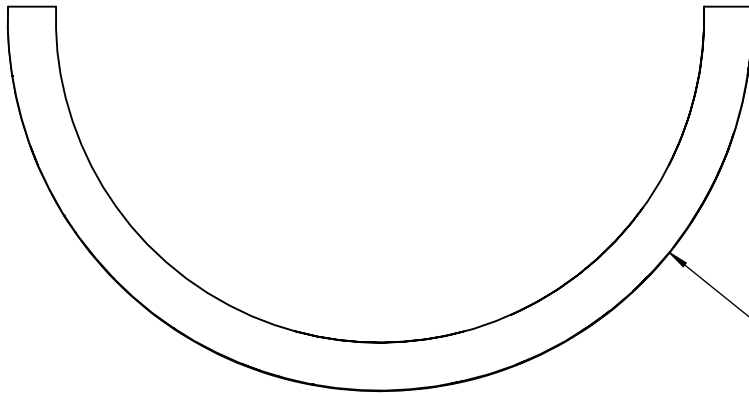

R3 7/8"

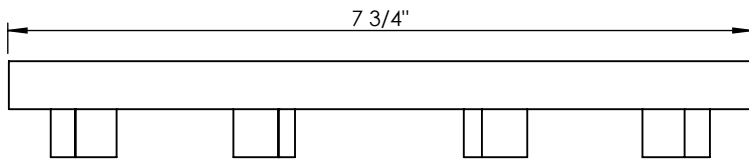
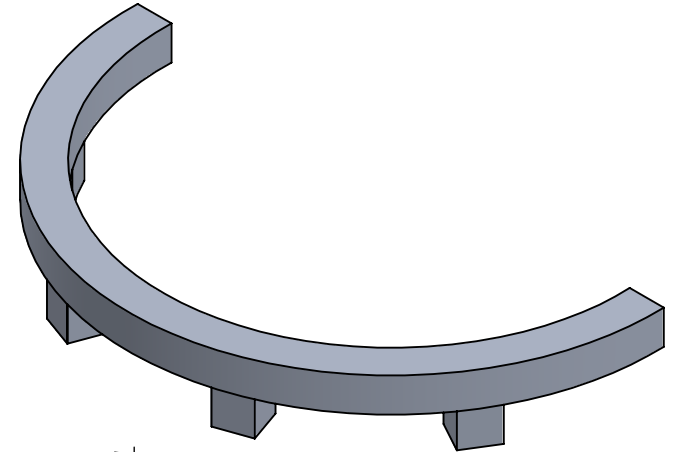

7 3/4"

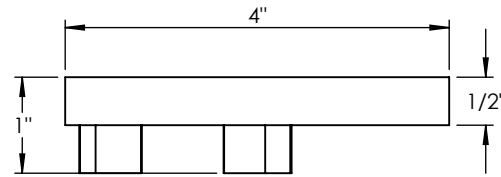

4"

1/2"

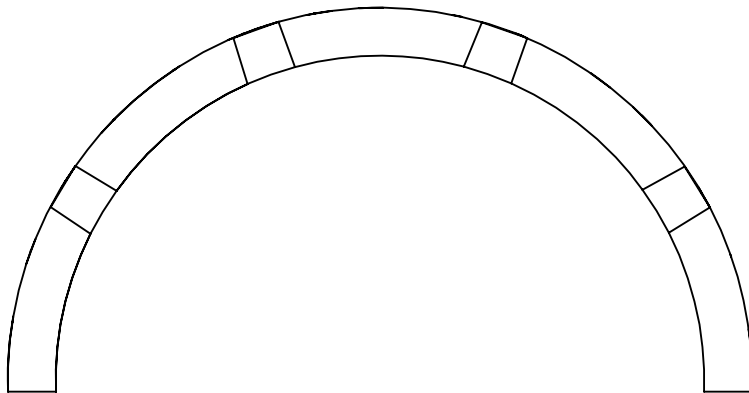

1/2"

**PROPRIETARY AND CONFIDENTIAL**  
 THE INFORMATION CONTAINED IN THIS DRAWING IS THE SOLE PROPERTY OF <INSERT COMPANY NAME HERE>. ANY REPRODUCTION IN PART OR AS A WHOLE WITHOUT THE WRITTEN PERMISSION OF <INSERT COMPANY NAME HERE> IS PROHIBITED.

		UNLESS OTHERWISE SPECIFIED:	NAME	DATE	1/2" SQUARE ALUMINUM BAR	
		DIMENSIONS ARE IN INCHES	DRAWN			TITLE:
		TOLERANCES: FRACTIONAL ± ANGULAR: MACH ± BEND ± TWO PLACE DECIMAL ± THREE PLACE DECIMAL ±	CHECKED			CE-W-15"-24W-SB-WF-PDIM-TBL-41K
		INTERPRET GEOMETRIC TOLERANCING PER:	ENG APPR.			
		MATERIAL	MFG APPR.			
		FINISH	Q.A.			
NEXT ASSY	USED ON		COMMENTS:		SIZE DWG. NO. REV	
APPLICATION		DO NOT SCALE DRAWING			SCALE: 1:2 WEIGHT: SHEET 4 OF 5	

ITEM NO.	PART NUMBER	DESCRIPTION	QTY.
1	CE-W-15"-24W-SB-WF-PDIM-TBL-41K-SPUN CAP	SPUN 22 GAUGE	1

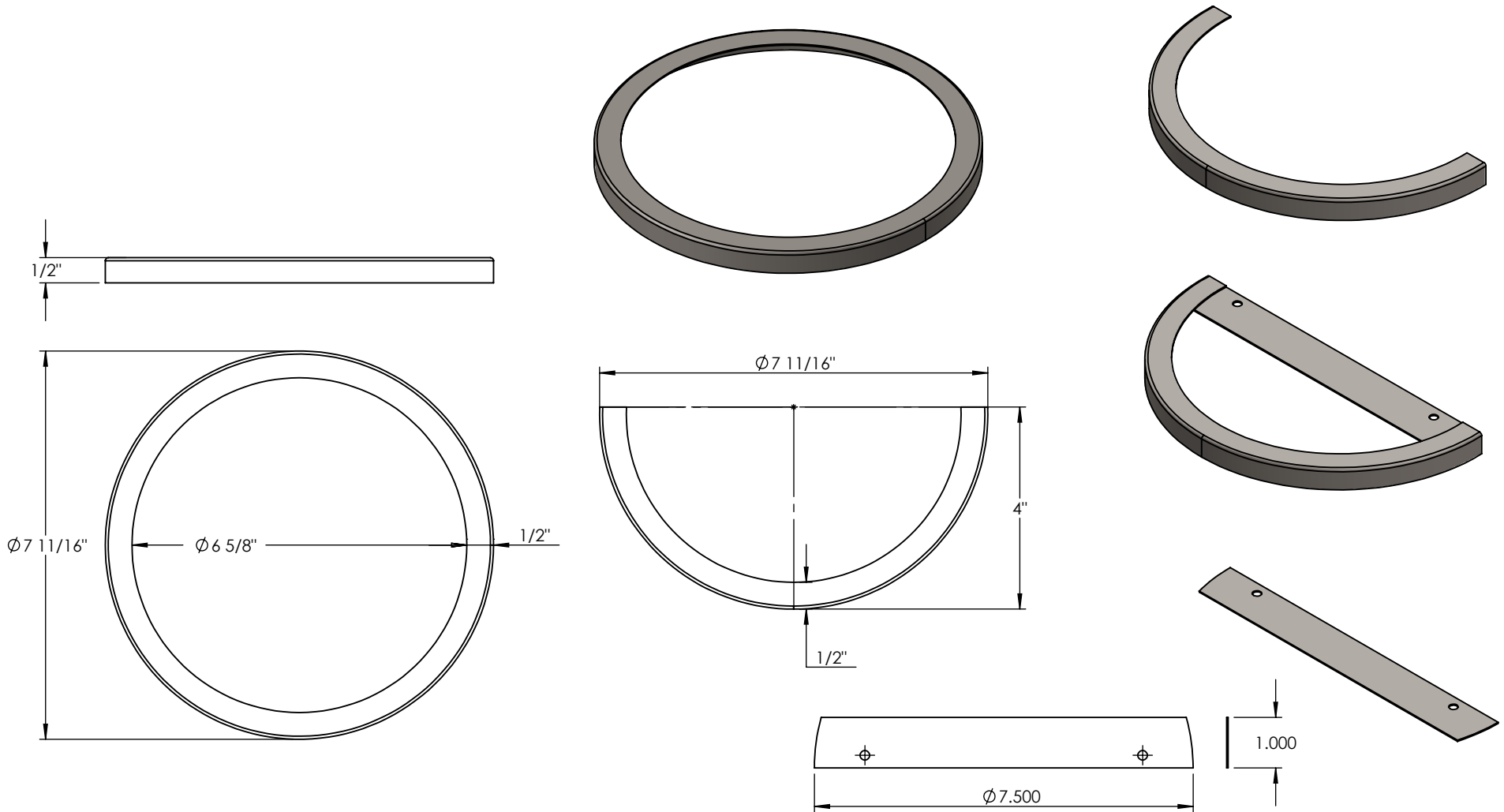

**PROPRIETARY AND CONFIDENTIAL**  
 THE INFORMATION CONTAINED IN THIS DRAWING IS THE SOLE PROPERTY OF <INSERT COMPANY NAME HERE>. ANY REPRODUCTION IN PART OR AS A WHOLE WITHOUT THE WRITTEN PERMISSION OF <INSERT COMPANY NAME HERE> IS PROHIBITED.

		UNLESS OTHERWISE SPECIFIED:		NAME	DATE
		DIMENSIONS ARE IN INCHES	DRAWN		
		TOLERANCES:	CHECKED		
		FRACTIONAL ±	ENG APPR.		
		ANGULAR: MACH ± BEND ±	MFG APPR.		
		TWO PLACE DECIMAL ±	Q.A.		
		THREE PLACE DECIMAL ±	COMMENTS:		
		INTERPRET GEOMETRIC TOLERANCING PER:			
		MATERIAL			
NEXT ASSY	USED ON	FINISH			
APPLICATION		DO NOT SCALE DRAWING			

SPUN 22 GAUGE		
TITLE:		
CE-W-15"-24W-SB-WF-PDIM-TBL-41K		
SIZE	DWG. NO.	REV
<b>A</b>		
SCALE: 1:3	WEIGHT:	SHEET 5 OF 5