

ITEM NO.	PART NUMBER	DESCRIPTION	QTY.	CUT
1	VRTSHD-36"-BKLT-30LED-MW-41K-SHIELD PLATE	ALUMINUM 0.250" PLATE	1	
2	VRTSHD-36"-BKLT-30LED-MW-41K-BACKPLATE	22 GAUGE ALUMINUM	1	
3	VRTSHD-36"-BKLT-30LED-MW-41K-DRIVER BRACKET	22 GAUGE ALUMINUM	1	
4	VRTSHD-36"-BKLT-30LED-MW-41K-FIREPLATE	22 GAUGE ALUMINUM	1	
5	VRTSHD-36"-BKLT-30LED-MW-41K-BACKPLATE TAB	22 GAUGE	4	
6	Altiled_PN110B_RevC	LED	2	
7	ESPEN VEL29070MVH-1	DRIVER	1	

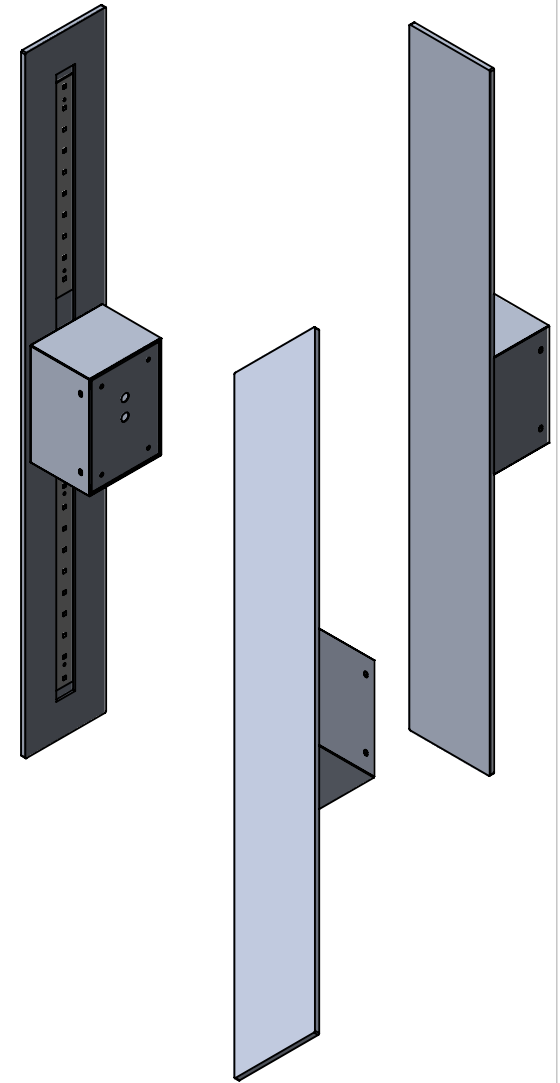
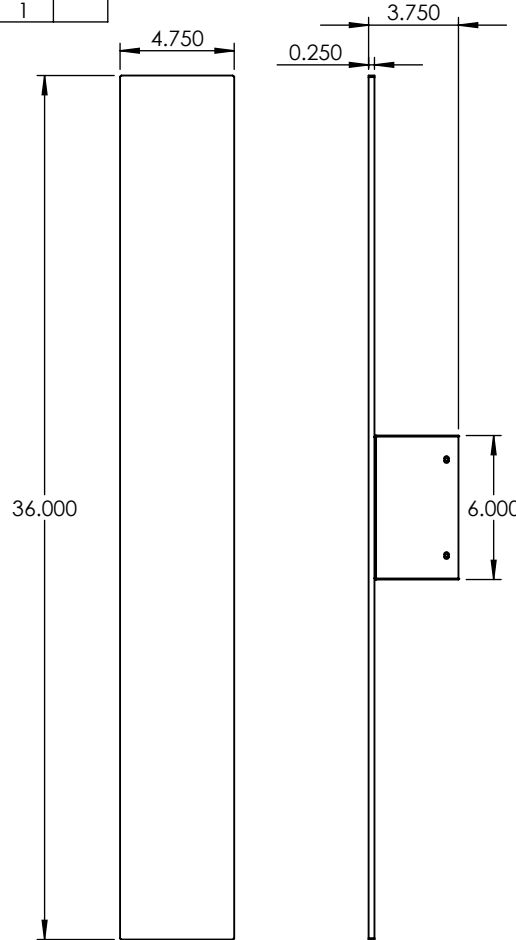
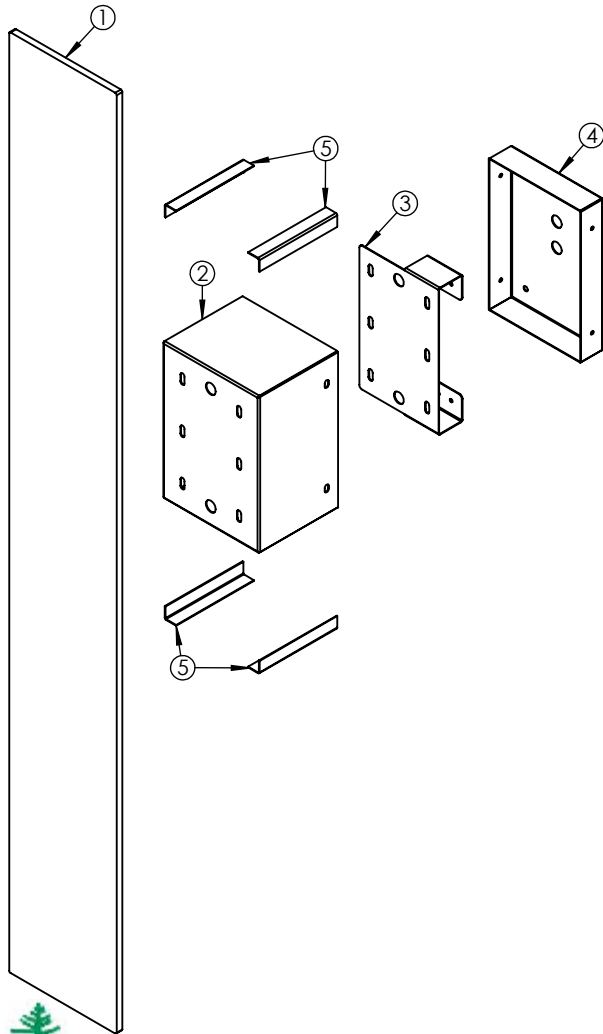

EVERGREEN LIGHTING

ALL BEND RADIUS .030"

APPLICATION

DO NOT SCALE DRAWING

UNLESS OTHERWISE SPECIFIED:

DIMENSIONS ARE IN INCHES
 TOLERANCES:
 FRACTIONAL ± .003
 ANGULAR: MACH ± .01 BEND ±
 TWO PLACE DECIMAL ±
 THREE PLACE DECIMAL ±.001

INTERPRET GEOMETRIC
 TOLERANCING PER:

MATERIAL

FINISH

NAME

DATE

DRAWN

CHECKED

ENG APPR.

MFG APPR.

Q.A.

COMMENTS:

TITLE:

VRTSHD-36"-BKLT-30LED-MW-41K-ASSEMBLY

SIZE DWG. NO.

REV

A TICKET 24483

SCALE: 1:8

WEIGHT:

SHEET 1 OF 5

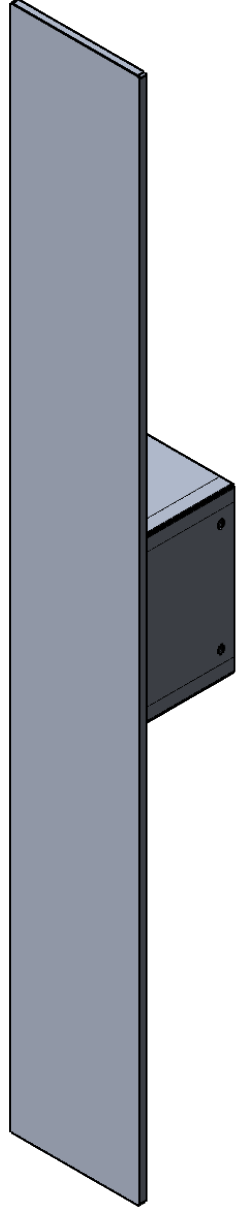
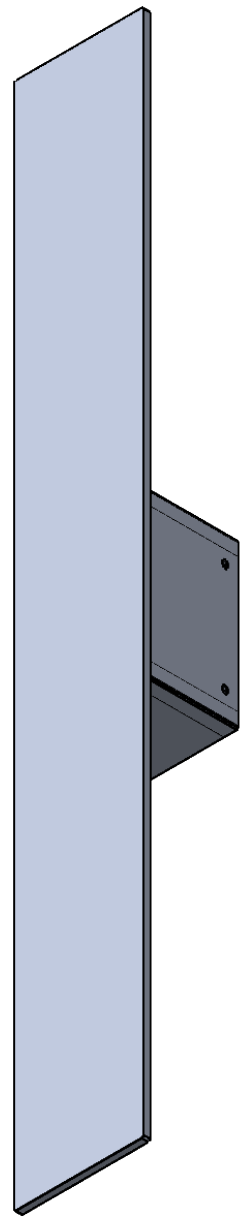
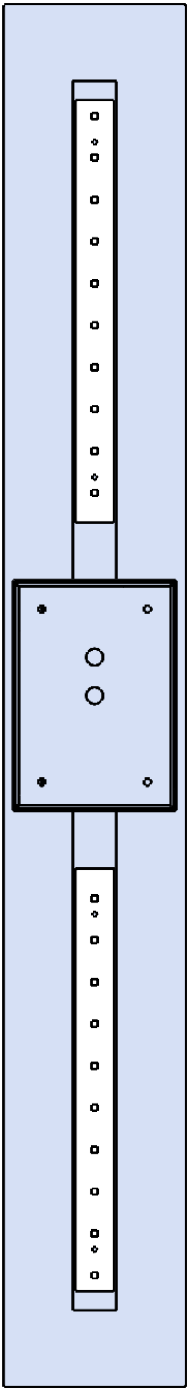
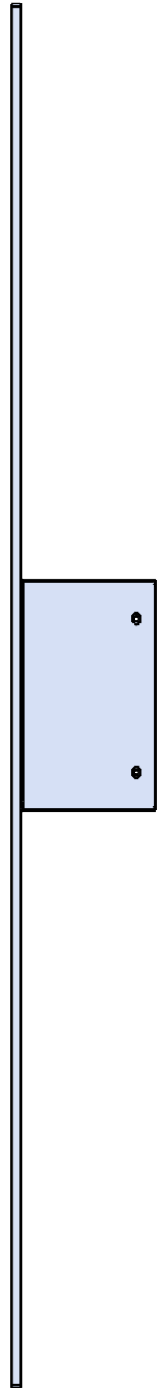
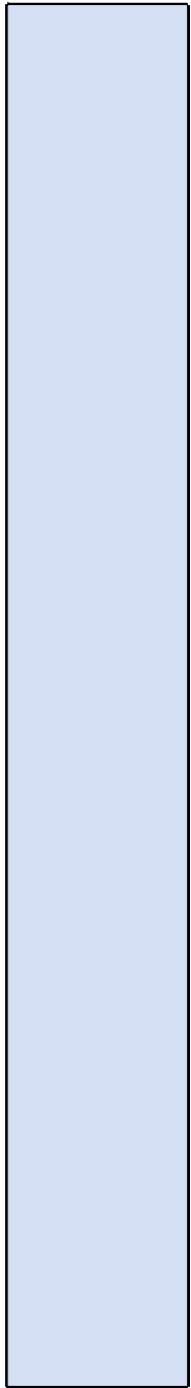

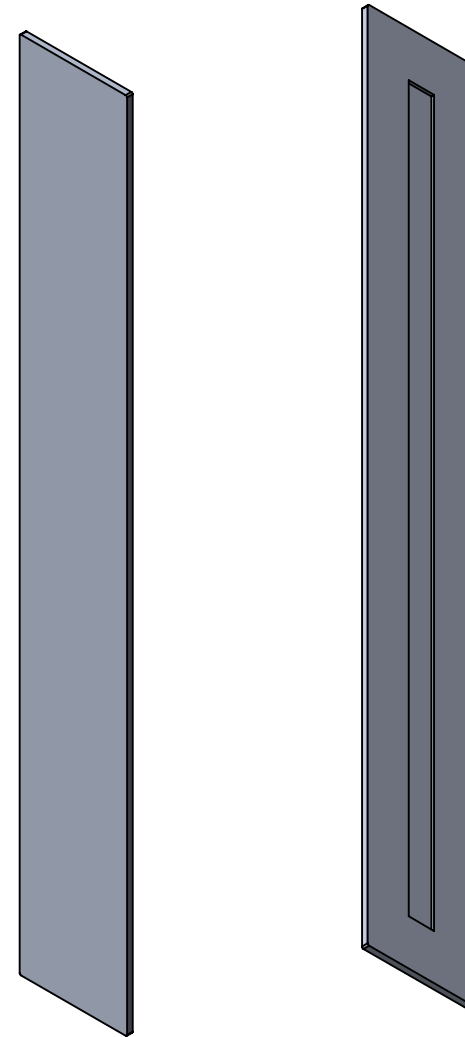
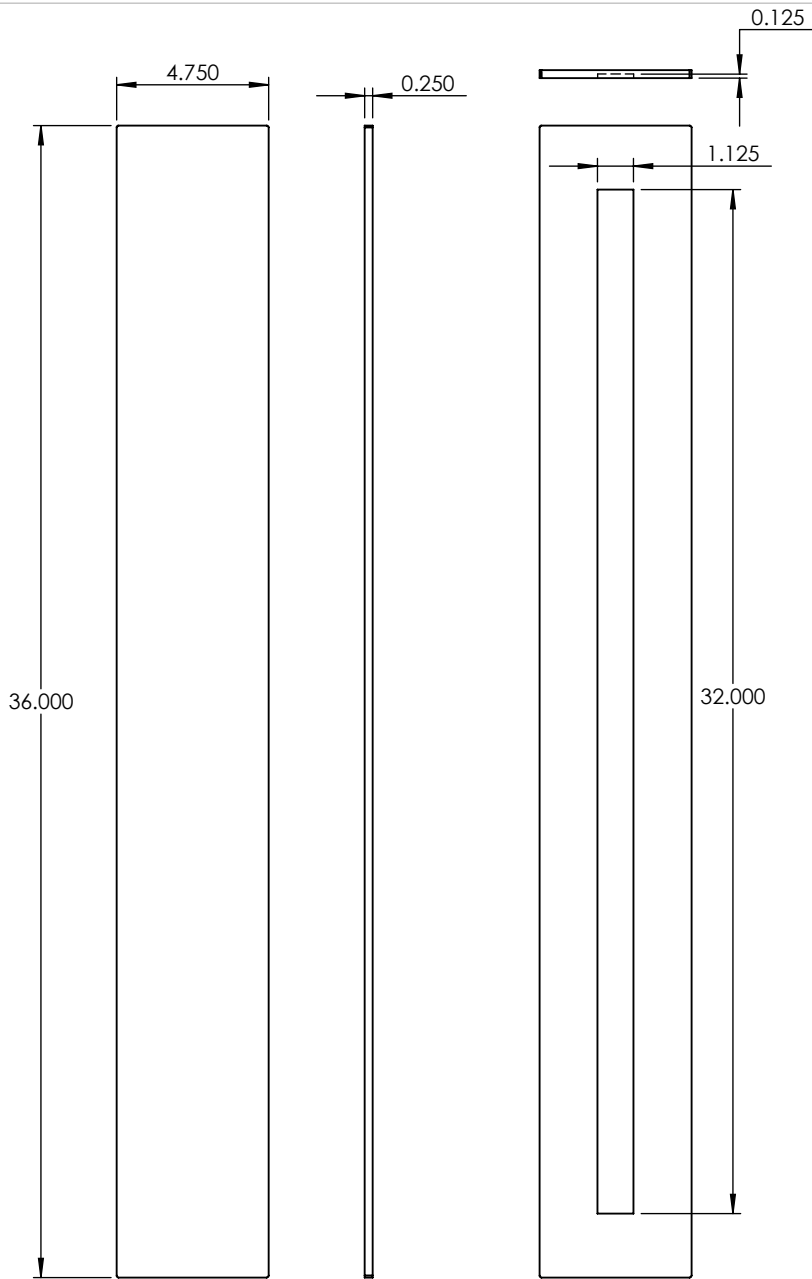

UNLESS OTHERWISE SPECIFIED:		NAME	DATE	ALUMINUM 0.250" PLATE	
DIMENSIONS ARE IN INCHES TOLERANCES: FRACTIONAL ± ANGULAR: MACH ± BEND ± TWO PLACE DECIMAL ± THREE PLACE DECIMAL ±		DRAWN			
INTERPRET GEOMETRIC TOLERANCING PER:		CHECKED		VRTSHD-36"-BKLT-30LED-MW-41K-ASSEMBLY	
MATERIAL		ENG APPR.			
FINISH		MFG APPR.		SIZE DWG. NO. REV	
DO NOT SCALE DRAWING		Q.A.		SCALE: 1:6 WEIGHT: SHEET 3 OF 5	
APPLICATION		COMMENTS:			

PROPRIETARY AND CONFIDENTIAL
THE INFORMATION CONTAINED IN THIS DRAWING IS THE SOLE PROPERTY OF <INSERT COMPANY NAME HERE>. ANY REPRODUCTION IN PART OR AS A WHOLE WITHOUT THE WRITTEN PERMISSION OF <INSERT COMPANY NAME HERE> IS PROHIBITED.

NEXT ASSY	USED ON
APPLICATION	

5

4

3

2

1

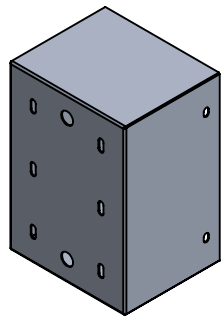
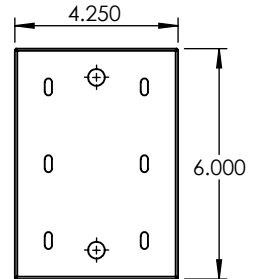
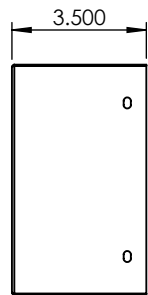
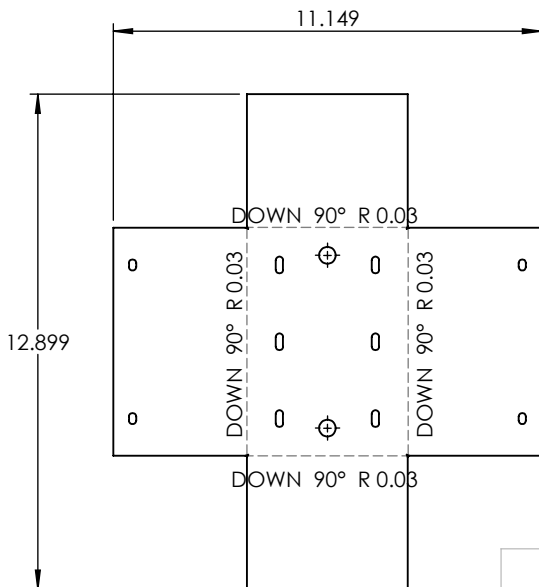
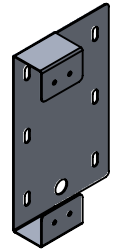
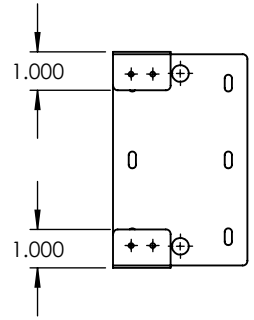
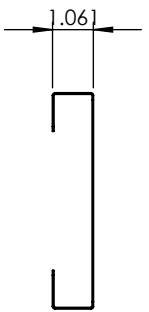
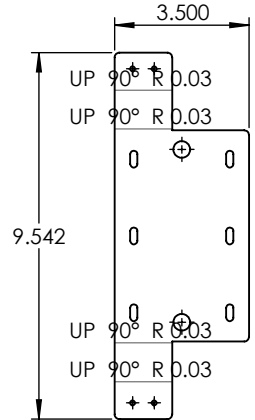
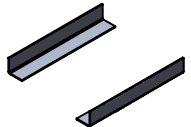
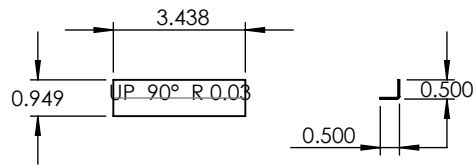

PROPRIETARY AND CONFIDENTIAL
 THE INFORMATION CONTAINED IN THIS DRAWING IS THE SOLE PROPERTY OF <INSERT COMPANY NAME HERE>. ANY REPRODUCTION IN PART OR AS A WHOLE WITHOUT THE WRITTEN PERMISSION OF <INSERT COMPANY NAME HERE> IS PROHIBITED.

		UNLESS OTHERWISE SPECIFIED:	NAME	DATE
		DIMENSIONS ARE IN INCHES	DRAWN	
		TOLERANCES:	CHECKED	
		FRACTIONAL ±	ENG APPR.	
		ANGULAR: MACH ± BEND ±	MFG APPR.	
		TWO PLACE DECIMAL ±	Q.A.	
		THREE PLACE DECIMAL ±	COMMENTS:	
		INTERPRET GEOMETRIC TOLERANCING PER:		
		MATERIAL		
NEXT ASSY	USED ON	FINISH		
APPLICATION		DO NOT SCALE DRAWING		

22 GAUGE ALUMINUM		
TITLE:		
VRTSHD-36"-BKLT-30LED-MW-41K-ASSEMBLY		
SIZE	DWG. NO.	REV
A		
SCALE: 1:5	WEIGHT:	SHEET 4 OF 5

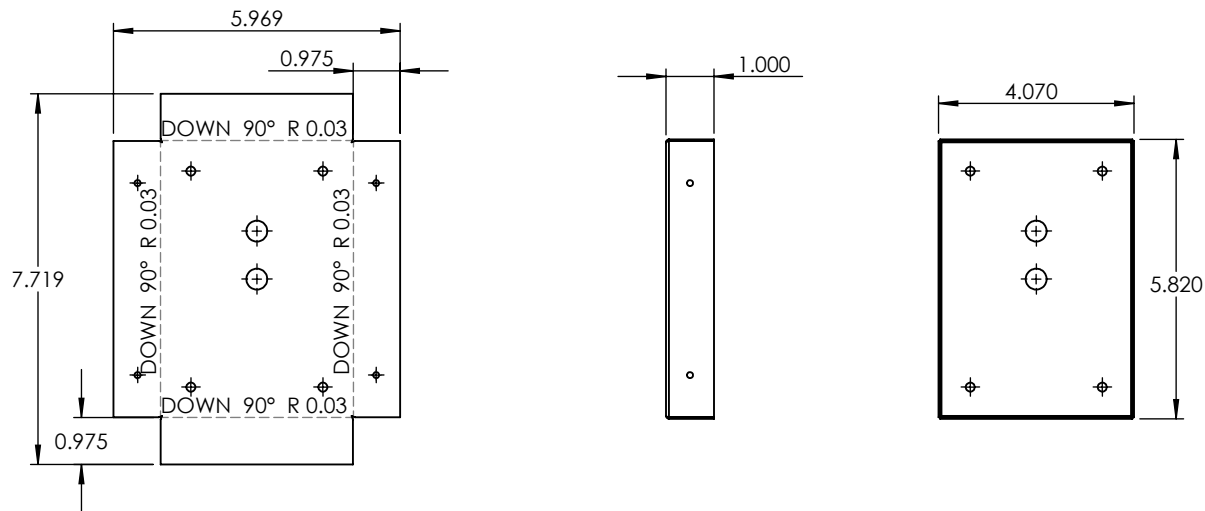
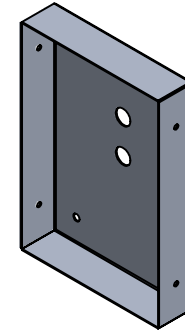

PROPRIETARY AND CONFIDENTIAL
 THE INFORMATION CONTAINED IN THIS DRAWING IS THE SOLE PROPERTY OF <INSERT COMPANY NAME HERE>. ANY REPRODUCTION IN PART OR AS A WHOLE WITHOUT THE WRITTEN PERMISSION OF <INSERT COMPANY NAME HERE> IS PROHIBITED.

		UNLESS OTHERWISE SPECIFIED:		NAME	DATE
		DIMENSIONS ARE IN INCHES	DRAWN		
		TOLERANCES:	CHECKED		
		FRACTIONAL ±	ENG APPR.		
		ANGULAR: MACH ± BEND ±	MFG APPR.		
		TWO PLACE DECIMAL ±	Q.A.		
		THREE PLACE DECIMAL ±	COMMENTS:		
		INTERPRET GEOMETRIC TOLERANCING PER:			
		MATERIAL			
		FINISH			
NEXT ASSY	USED ON				
APPLICATION		DO NOT SCALE DRAWING			

22 GAUGE ALUMINUM		
TITLE:		
VRTSHD-36"-BKLT-30LED-MW-41K-ASSEMBLY		
SIZE	DWG. NO.	REV
A		
SCALE: 1:4	WEIGHT:	SHEET 5 OF 5

5

4

3

2

1