

ITEM NO.	PART NUMBER	DESCRIPTION	QTY.	CUT
1	MK-W-160A-ORB-A-BLACKPLATE	ALL 22 GAUGE	1	
2	MK-W-160A-ORB-A-FRAME	22 GAUGE	1	
3	MK-W-160A-ORB-A-STRIPS	22 GAUGE	2	
4	MK-W-160A-ORB-A-WIRE SQUARE	22 GAUGE	1	
5	MK-W-160A-ORB-A-ACRYLIC	ACRYLIC	1	
6	MK-W-160A-ORB-A-FRAME WIRE	WIRE 11" IN LENGTH	2	
7	BRASS HALF BALL	1" HALF BRASS BALL	1	
8	GU24 INCANDESCENT LIGHT BULB	BULB	1	

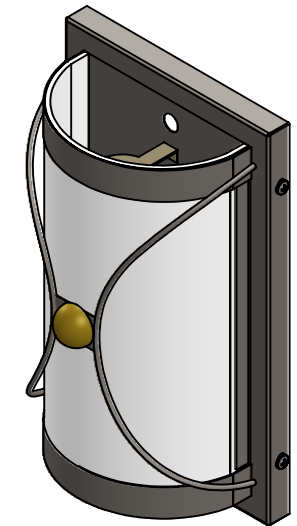

UNLESS OTHERWISE SPECIFIED: DIMENSIONS ARE IN INCHES TOLERANCES: FRACTIONAL ± .003 ANGULAR: MACH ± .01 BEND ± TWO PLACE DECIMAL ± THREE PLACE DECIMAL ±.001 INTERPRET GEOMETRIC TOLERANCING PER: MATERIAL FINISH	NAME	DATE	TITLE: MK-W-160A-ORB-A SIZE DWG. NO. REV A TICKET 24842 SCALE: 1:4 WEIGHT: SHEET 1 OF 4
	DRAWN		
	CHECKED		
	ENG APPR.		
	MFG APPR.		
	Q.A.		
	COMMENTS:		

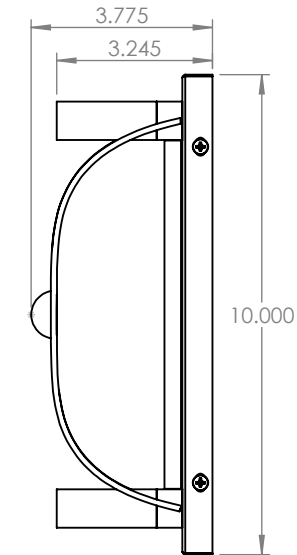
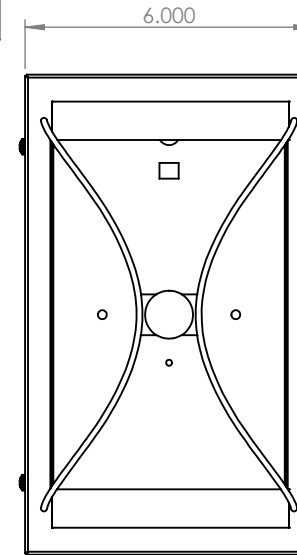
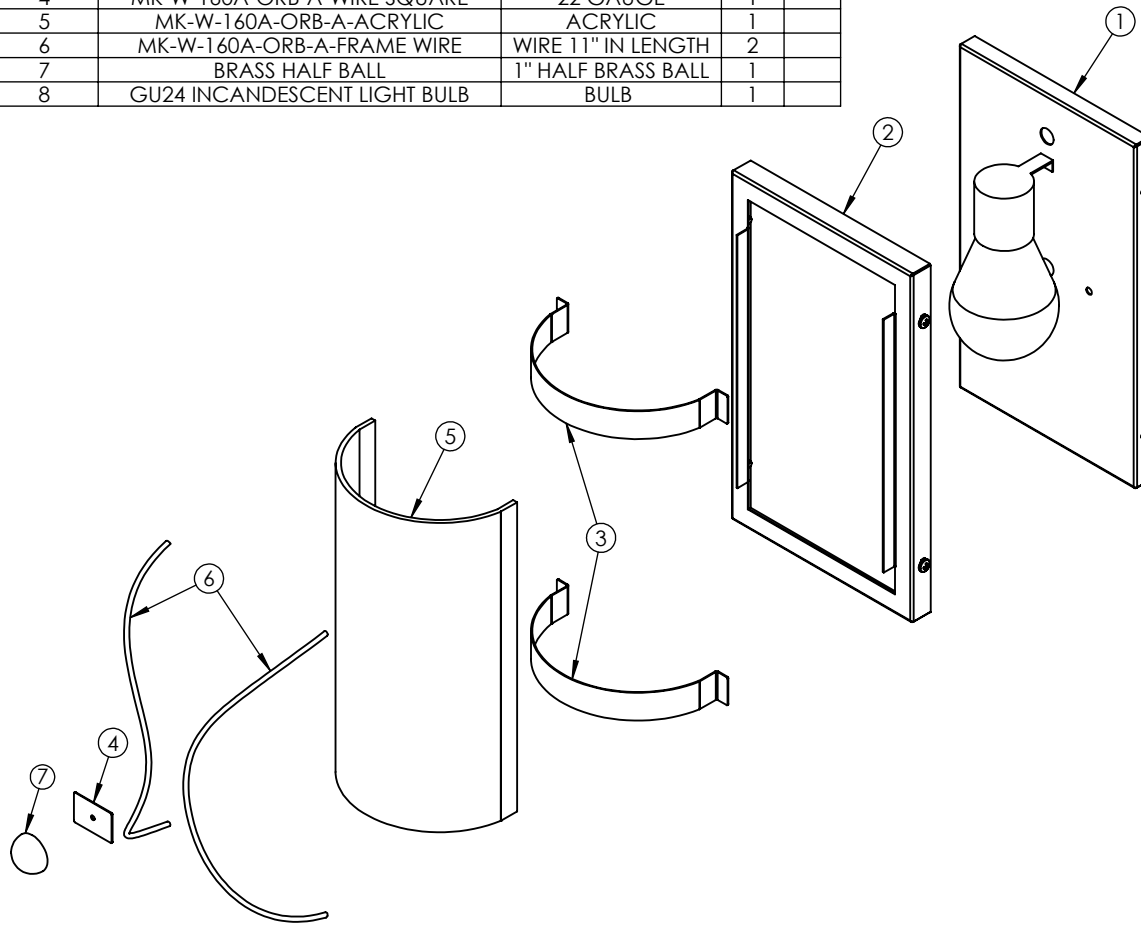

ALL BEND RADIUS .030"

APPLICATION

DO NOT SCALE DRAWING

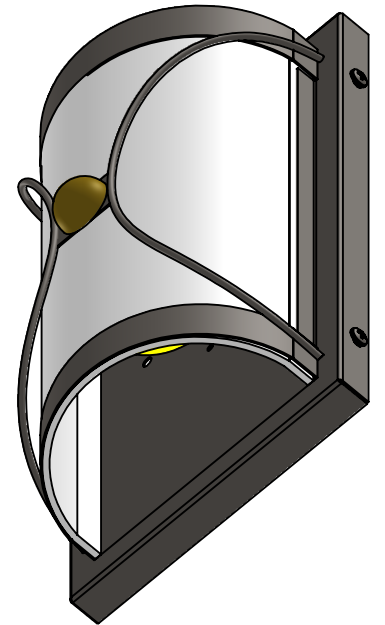
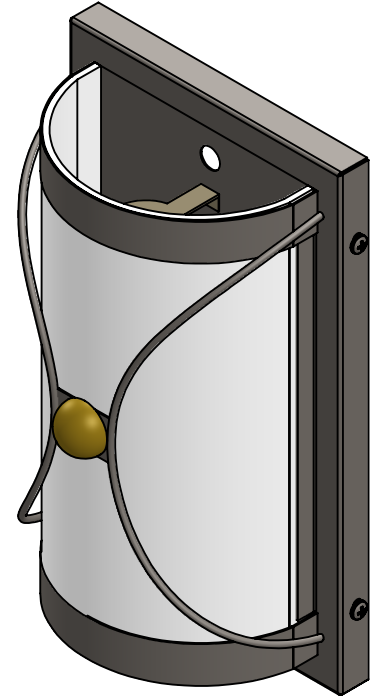
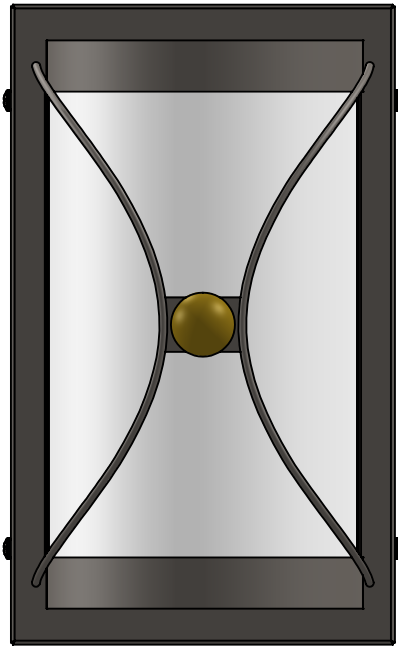
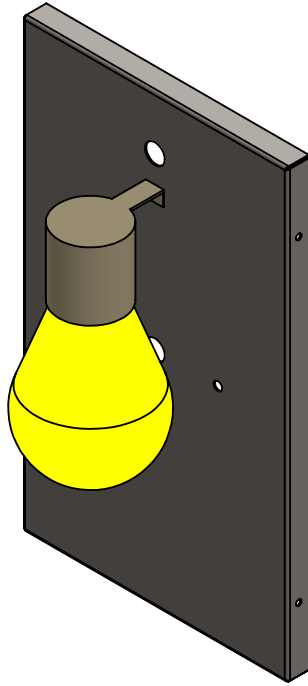
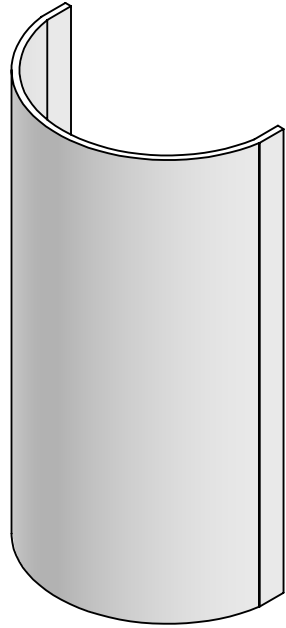
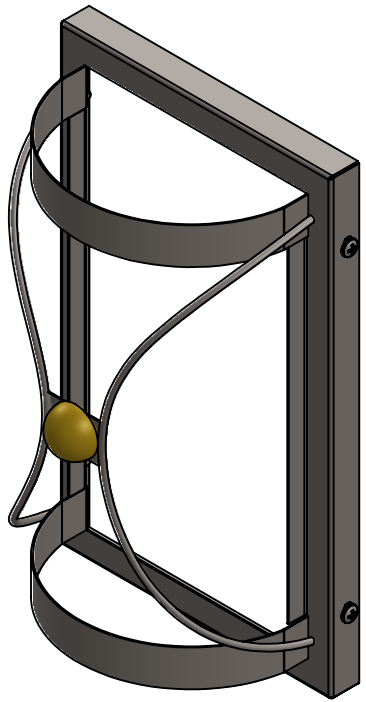

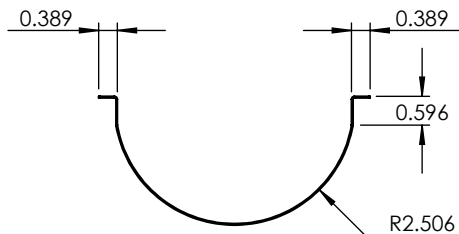
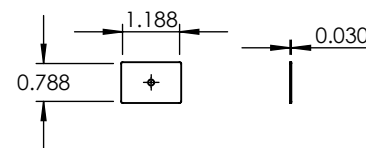
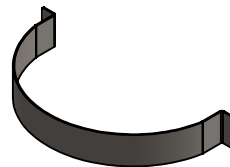
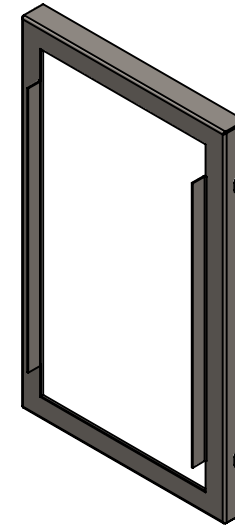
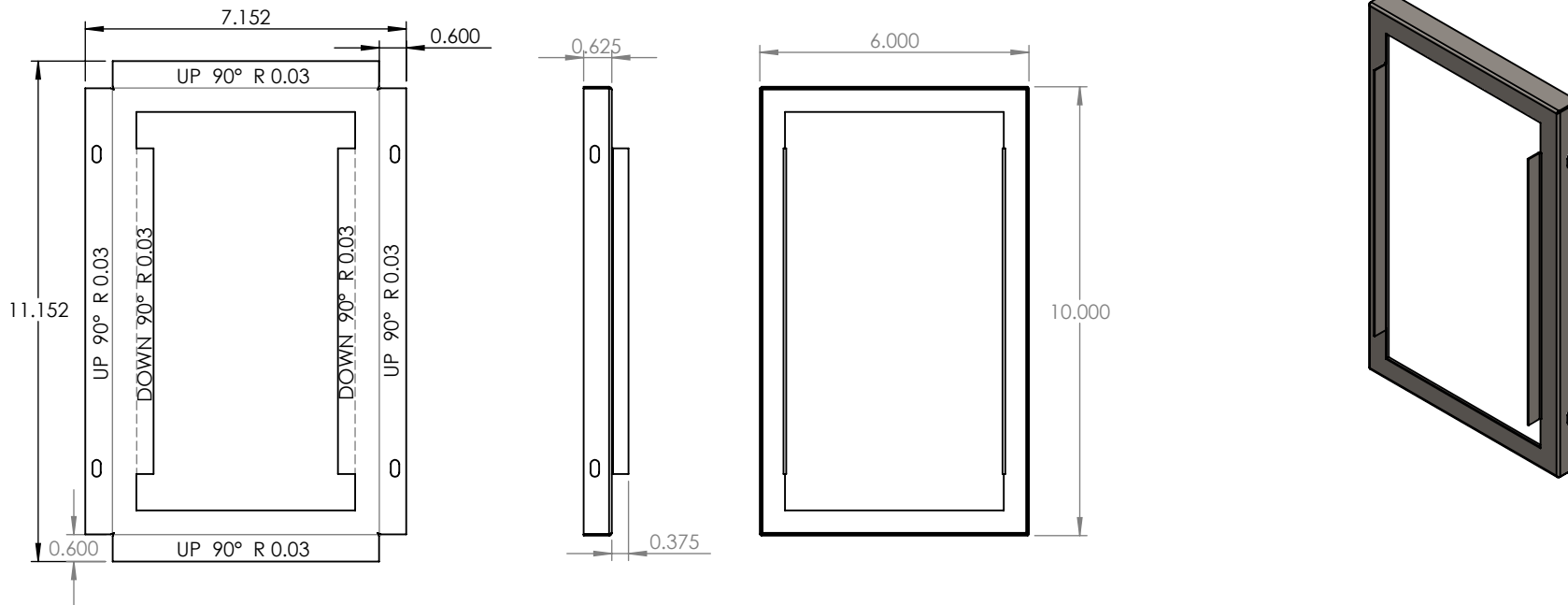

UNLESS OTHERWISE SPECIFIED:		NAME	DATE	22 GAUGE	
DIMENSIONS ARE IN INCHES TOLERANCES: FRACTIONAL ± ANGULAR: MACH ± BEND ± TWO PLACE DECIMAL ± THREE PLACE DECIMAL ±		DRAWN		TITLE:	
		CHECKED		MK-W-160A-ORB-A	
		ENG APPR.		SIZE	DWG. NO.
		MFG APPR.		A	REV
		Q.A.		SCALE: 1:4	WEIGHT:
		COMMENTS:		SHEET 3 OF 4	
INTERPRET GEOMETRIC TOLERANCING PER:					
MATERIAL					
FINISH					
NEXT ASSY	USED ON				
APPLICATION		DO NOT SCALE DRAWING			

PROPRIETARY AND CONFIDENTIAL
THE INFORMATION CONTAINED IN THIS DRAWING IS THE SOLE PROPERTY OF <INSERT COMPANY NAME HERE>. ANY REPRODUCTION IN PART OR AS A WHOLE WITHOUT THE WRITTEN PERMISSION OF <INSERT COMPANY NAME HERE> IS PROHIBITED.

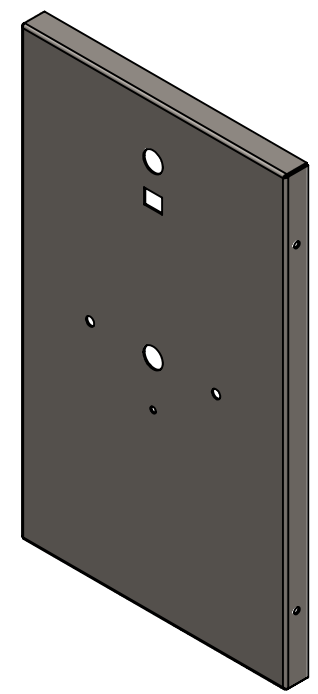
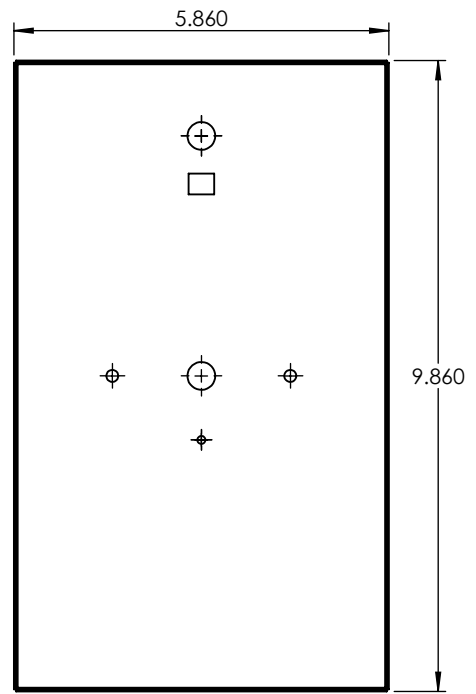
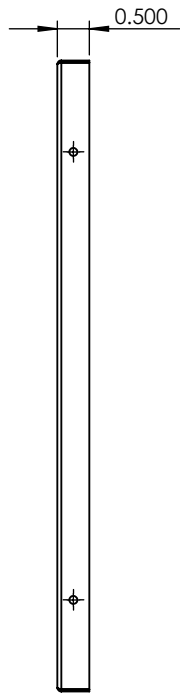
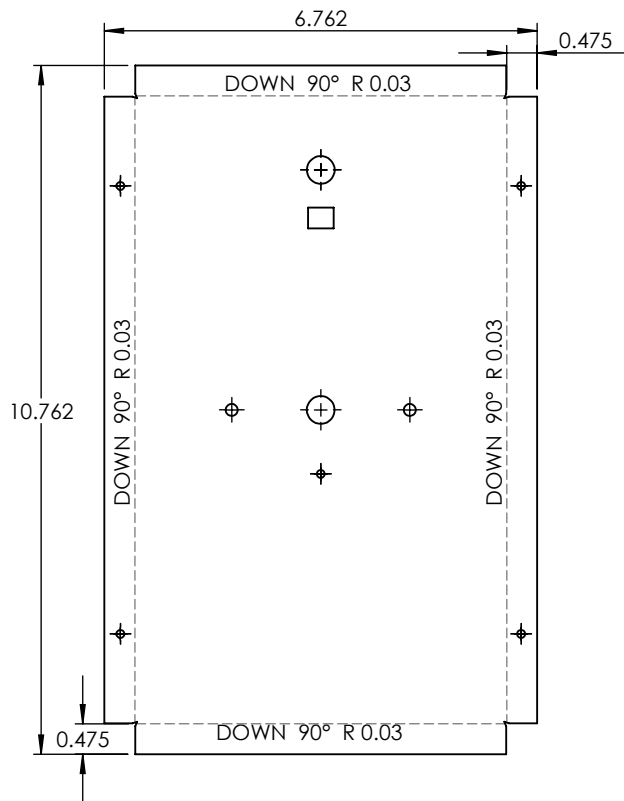

PROPRIETARY AND CONFIDENTIAL
 THE INFORMATION CONTAINED IN THIS DRAWING IS THE SOLE PROPERTY OF <INSERT COMPANY NAME HERE>. ANY REPRODUCTION IN PART OR AS A WHOLE WITHOUT THE WRITTEN PERMISSION OF <INSERT COMPANY NAME HERE> IS PROHIBITED.

		INTERPRET GEOMETRIC TOLERANCING PER:
		MATERIAL
NEXT ASSY	USED ON	FINISH
APPLICATION		DO NOT SCALE DRAWING

UNLESS OTHERWISE SPECIFIED:
 DIMENSIONS ARE IN INCHES
 TOLERANCES:
 FRACTIONAL ±
 ANGULAR: MACH ± BEND ±
 TWO PLACE DECIMAL ±
 THREE PLACE DECIMAL ±

	NAME	DATE
DRAWN		
CHECKED		
ENG APPR.		
MFG APPR.		
Q.A.		
COMMENTS:		

22 GAUGE		
TITLE: MK-W-160A-ORB-A		
SIZE A	DWG. NO.	REV
SCALE: 1:3	WEIGHT:	SHEET 4 OF 4

5

4

3

2

1