

ITEM NO.	PART NUMBER	DESCRIPTION	QTY.	CUT
1	MK-WCRS-213GU24-ORB-A-120V-BACKPLATE	22 GAUGE	1	
2	MK-WCRS-213GU24-ORB-A-120V-FRAME	22 GAUGE	1	
3	MK-WCRS-213GU24-ORB-A-120V-FRAME WIRE	WIRE 18.875" IN LENGTH	2	
4	MK-WCRS-213GU24-ORB-A-120V-ACRYLIC	ACRYLIC	1	
5	GU24 SOCKET FLOURESCENT LIGHT	SOCKET	2	

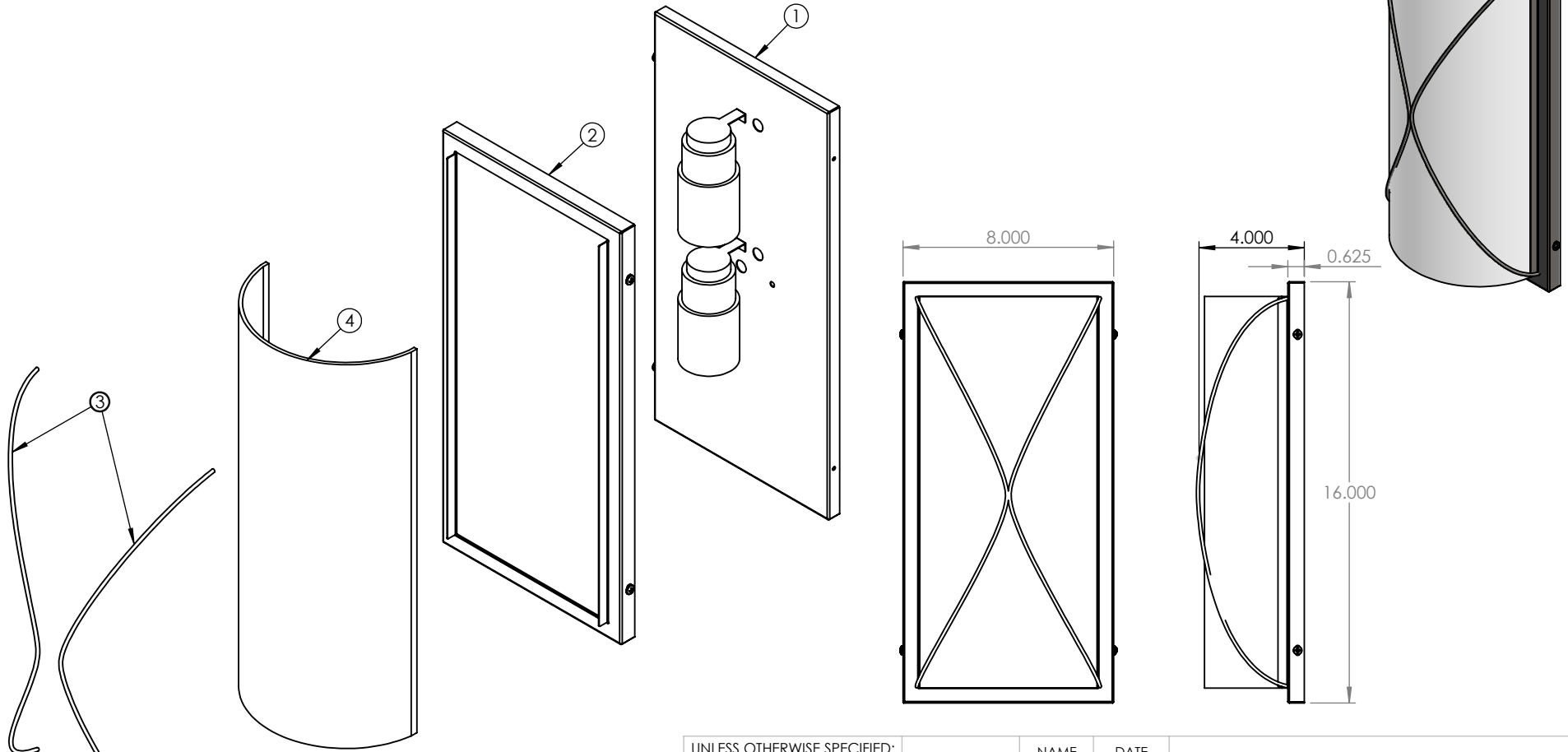

EVERGREEN LIGHTING

ALL BEND RADIUS .030"

APPLICATION

DO NOT SCALE DRAWING

UNLESS OTHERWISE SPECIFIED:

DIMENSIONS ARE IN INCHES
 TOLERANCES:
 FRACTIONAL ± .003
 ANGULAR: MACH ± .01 BEND ±
 TWO PLACE DECIMAL ±
 THREE PLACE DECIMAL ±.001

INTERPRET GEOMETRIC
 TOLERANCING PER:

MATERIAL

FINISH

NAME

DATE

DRAWN

CHECKED

ENG APPR.

MFG APPR.

Q.A.

COMMENTS:

TITLE:

MK-WCRS-213GU24-ORB-A-120V

SIZE DWG. NO.

REV

A TICKET 24842

SCALE: 1:5

WEIGHT:

SHEET 1 OF 4

5

4

3

2

1

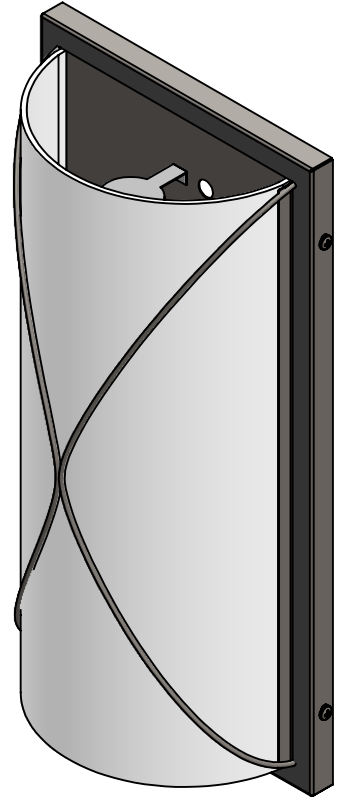
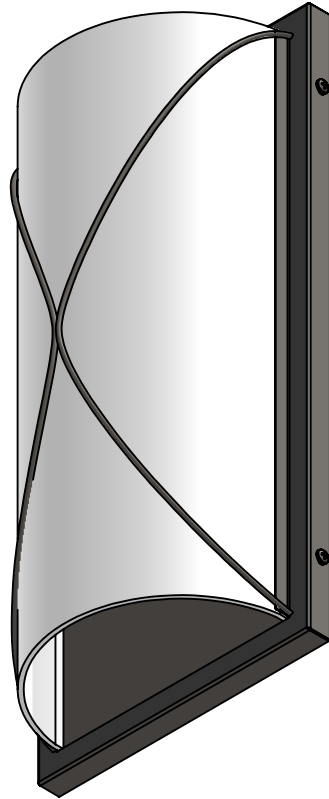
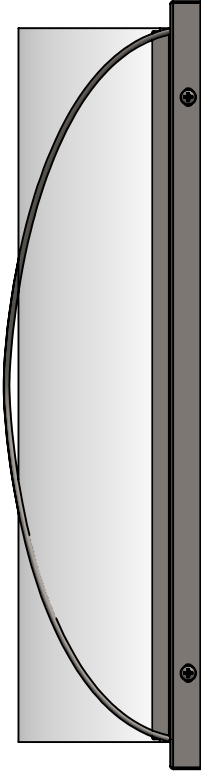
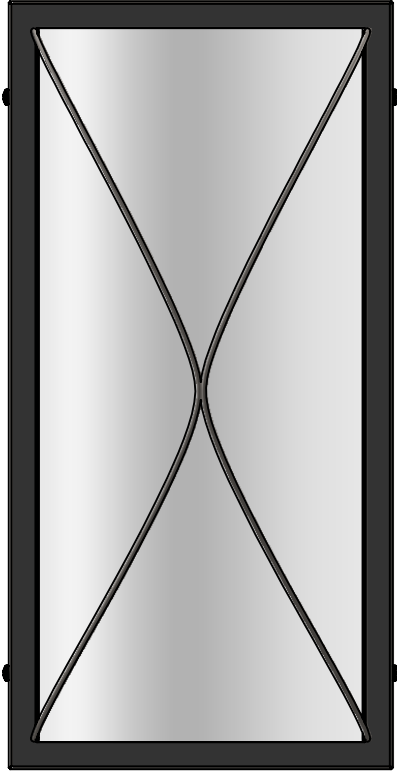

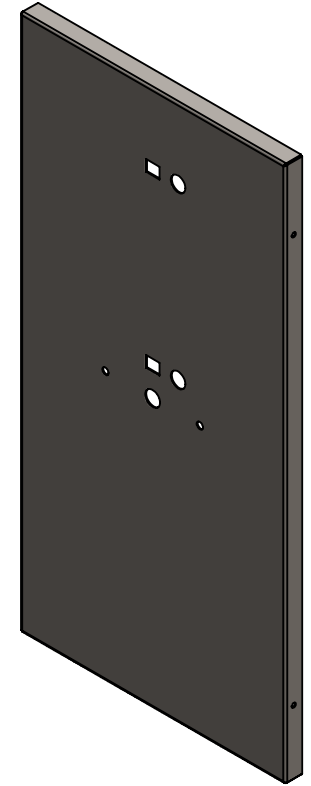
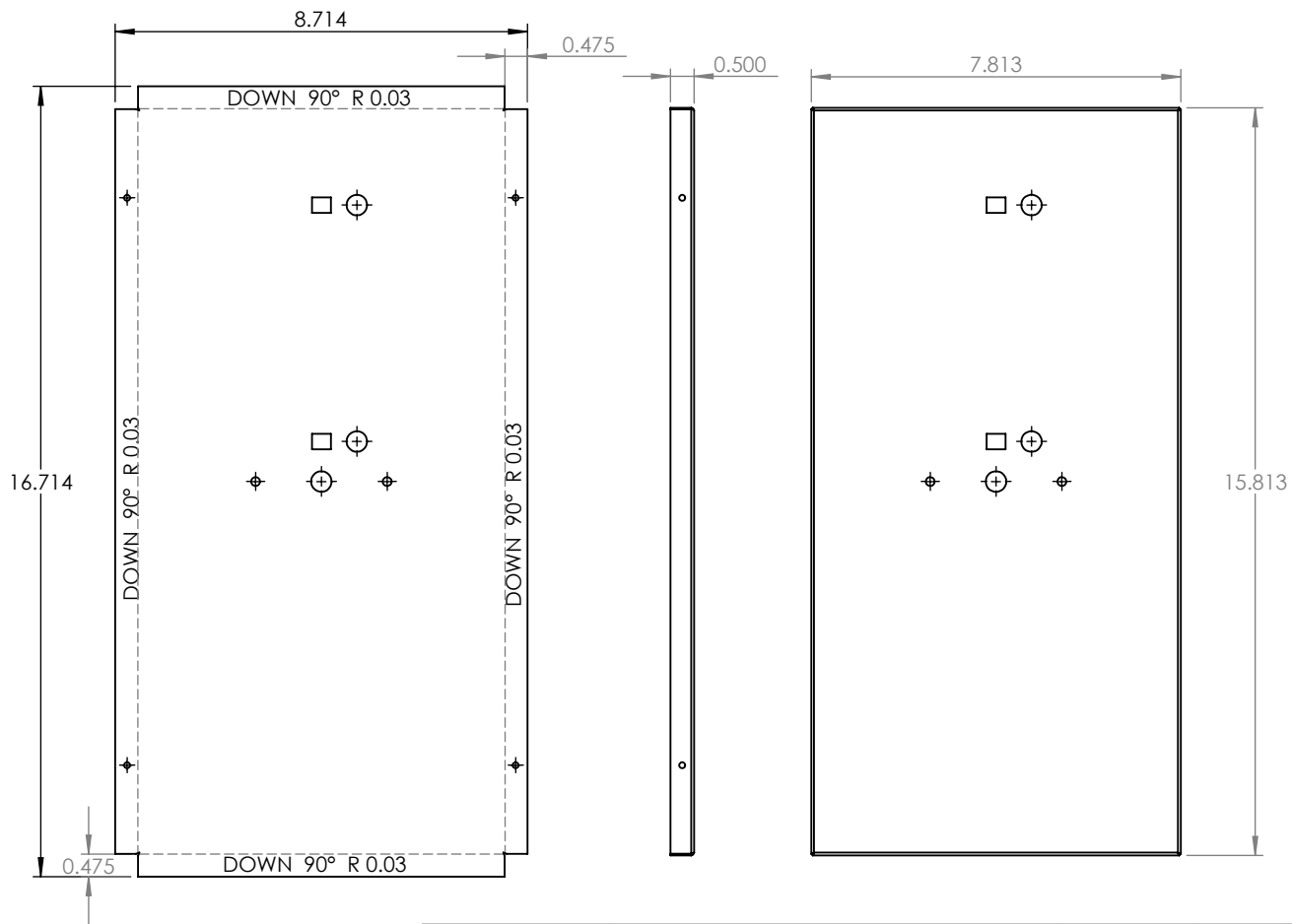

PROPRIETARY AND CONFIDENTIAL
 THE INFORMATION CONTAINED IN THIS DRAWING IS THE SOLE PROPERTY OF <INSERT COMPANY NAME HERE>. ANY REPRODUCTION IN PART OR AS A WHOLE WITHOUT THE WRITTEN PERMISSION OF <INSERT COMPANY NAME HERE> IS PROHIBITED.

		UNLESS OTHERWISE SPECIFIED:	NAME	DATE	22 GAUGE	
		DIMENSIONS ARE IN INCHES TOLERANCES: FRACTIONAL ± ANGULAR: MACH ± BEND ± TWO PLACE DECIMAL ± THREE PLACE DECIMAL ±	DRAWN			
		INTERPRET GEOMETRIC TOLERANCING PER:	CHECKED		SIZE DWG. NO. REV	
		MATERIAL	ENG APPR.			
NEXT ASSY	USED ON	FINISH	MFG APPR.	Q.A.		
APPLICATION		DO NOT SCALE DRAWING	COMMENTS:			

