

ITEM NO.	PART NUMBER	DESCRIPTION	QTY.	CUT
1	LA-W-12-24W-MBK-A-TBL-30K-FRAME	22 GAUGE	1	
2	LA-W-12-24W-MBK-A-TBL-30K-END CAP	22 GAUGE	2	
3	LA-W-12-24W-MBK-A-TBL-30K-BACKPLATE	22 GAUGE	1	
4	LA-W-12-24W-MBK-A-TBL-30K-ACRYLIC	ACRYLIC	1	
5	KTLD-25-UV-700-VDIM-LA1	DRIVER	1	
6	AlfaLED_PN1010_RevD	LED	4	

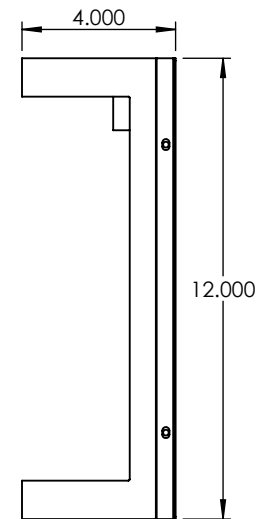
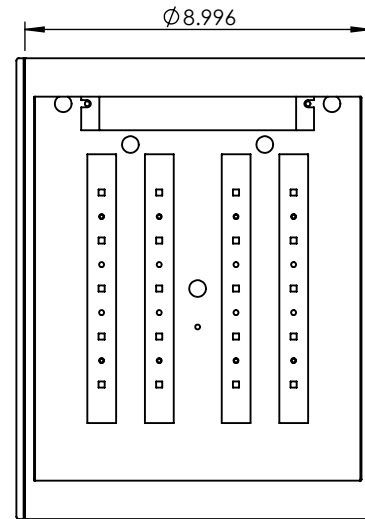
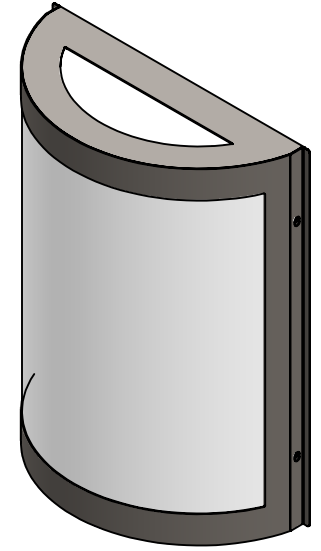
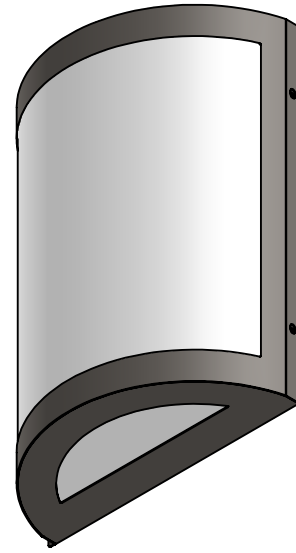
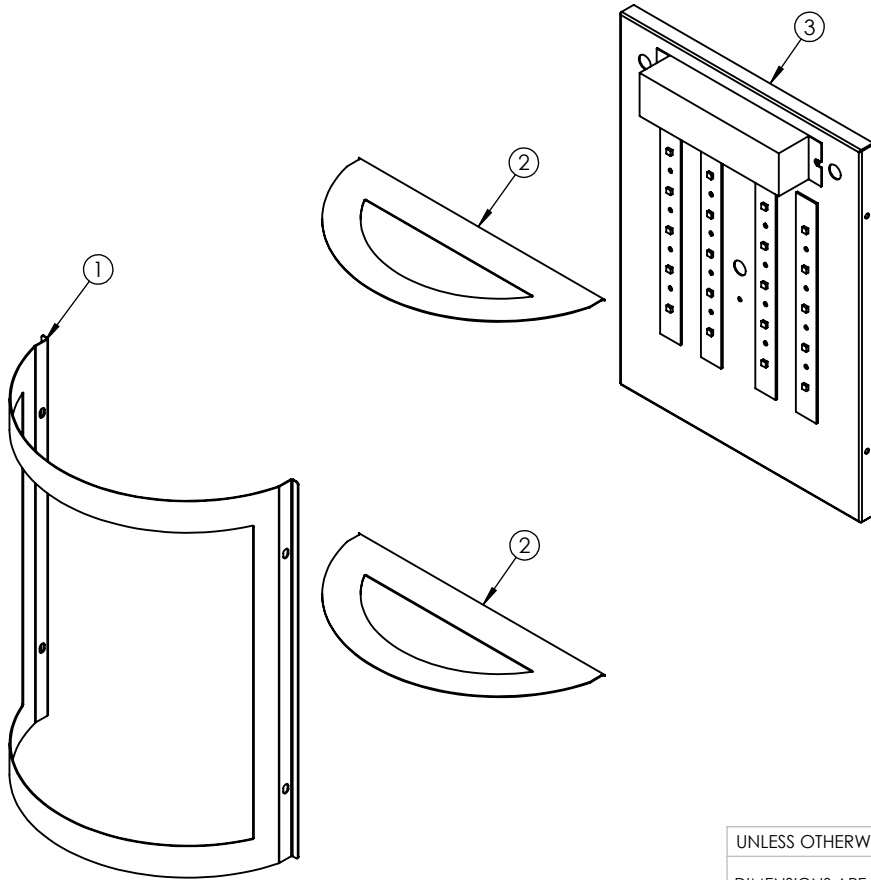

UNLESS OTHERWISE SPECIFIED:

DIMENSIONS ARE IN INCHES
 TOLERANCES:
 FRACTIONAL $\pm .003$
 ANGULAR: MACH $\pm .01$ BEND \pm
 TWO PLACE DECIMAL \pm
 THREE PLACE DECIMAL $\pm .001$

INTERPRET GEOMETRIC
 TOLERANCING PER:

MATERIAL

FINISH

ALL BEND RADIUS .030"

APPLICATION

DO NOT SCALE DRAWING

NAME

DATE

DRAWN

CHECKED

ENG APPR.

MFG APPR.

Q.A.

COMMENTS:

TITLE:

LA-W-12-24W-MBK-A-TBL-30K

SIZE DWG. NO.

A TICKET 25056

REV

SCALE: 1:5

WEIGHT:

SHEET 1 OF 6



EVERGREEN LIGHTING

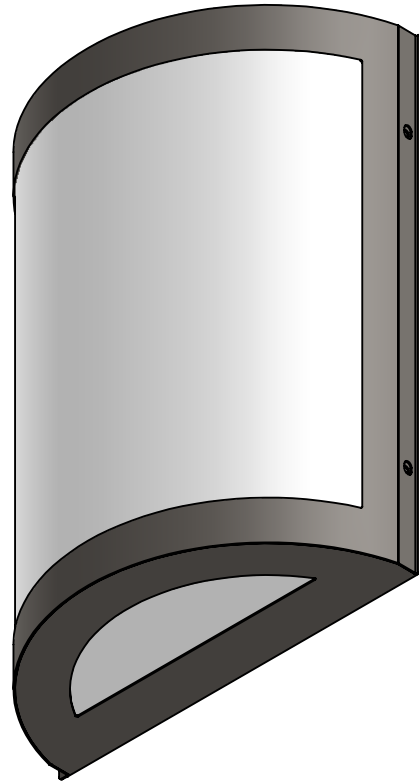
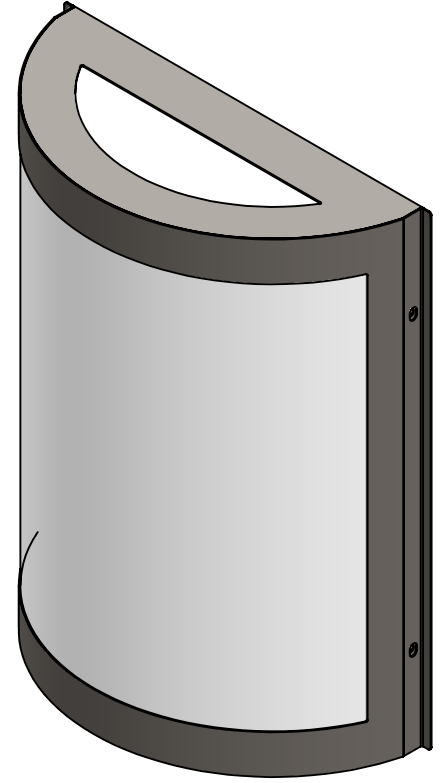
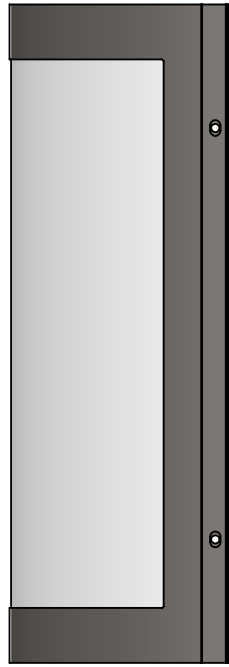

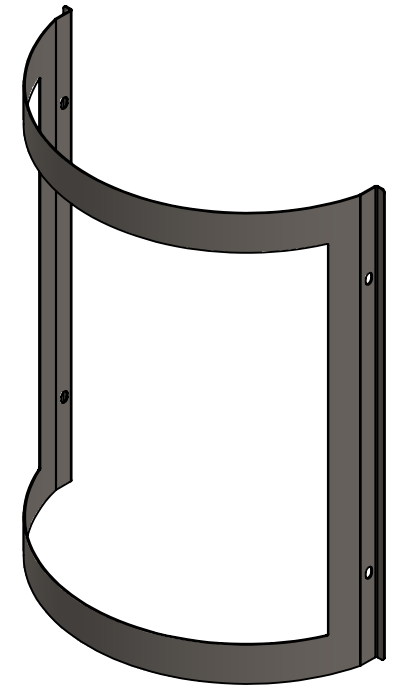
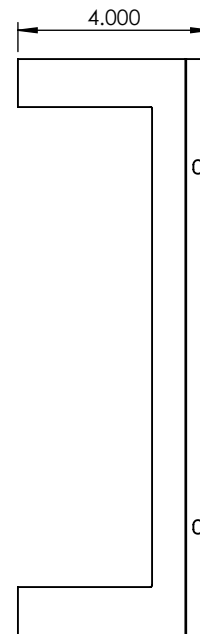
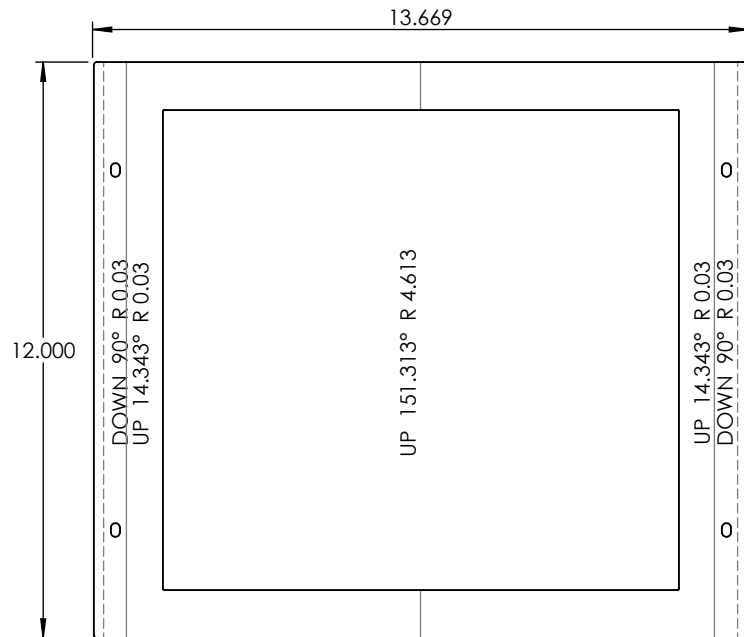
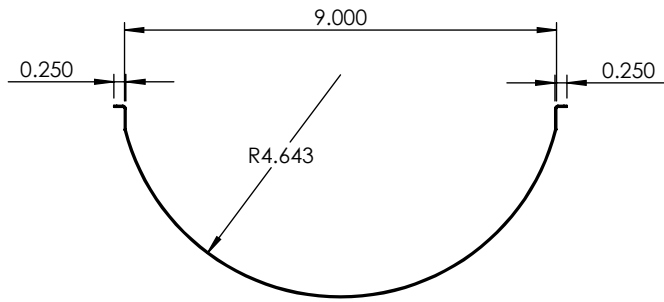

PROPRIETARY AND CONFIDENTIAL
 THE INFORMATION CONTAINED IN THIS DRAWING IS THE SOLE PROPERTY OF <INSERT COMPANY NAME HERE>. ANY REPRODUCTION IN PART OR AS A WHOLE WITHOUT THE WRITTEN PERMISSION OF <INSERT COMPANY NAME HERE> IS PROHIBITED.

		UNLESS OTHERWISE SPECIFIED:		NAME	DATE
		DIMENSIONS ARE IN INCHES	DRAWN		
		TOLERANCES:	CHECKED		
		FRACTIONAL ±	ENG APPR.		
		ANGULAR: MACH ± BEND ±	MFG APPR.		
		TWO PLACE DECIMAL ±	Q.A.		
		THREE PLACE DECIMAL ±	COMMENTS:		
		INTERPRET GEOMETRIC TOLERANCING PER:			
		MATERIAL			
		FINISH			
NEXT ASSY	USED ON				
APPLICATION		DO NOT SCALE DRAWING			

22 GAUGE		
TITLE:		
LA-W-12-24W-MBK-A-TBL-30K		
SIZE	DWG. NO.	REV
A		
SCALE: 1:4	WEIGHT:	SHEET 3 OF 6

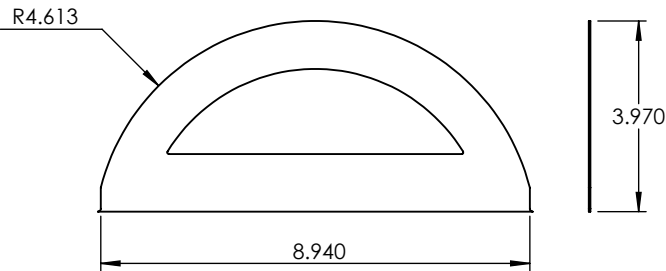
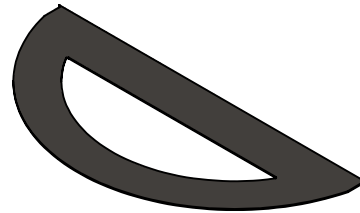
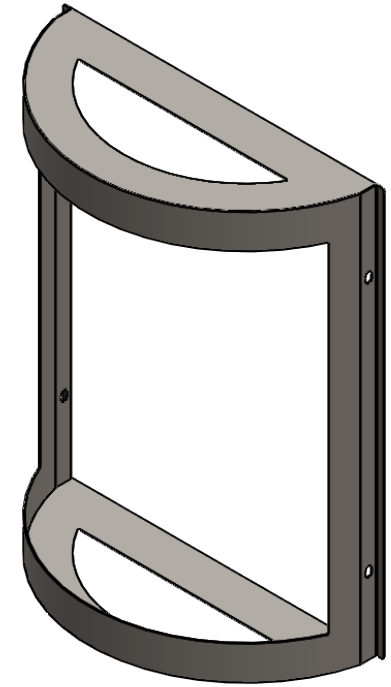
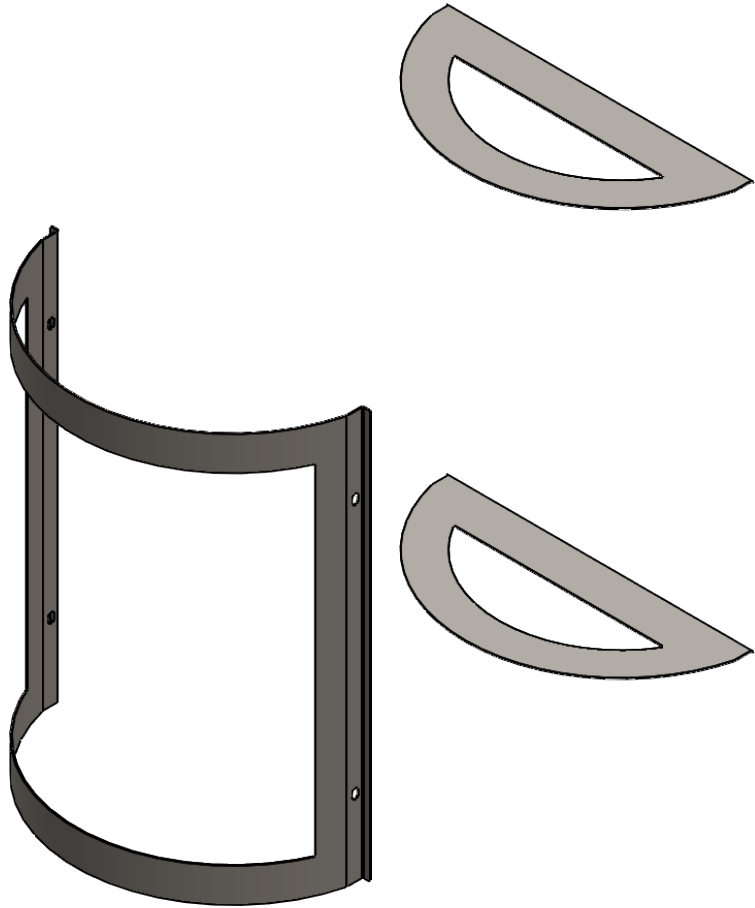

UNLESS OTHERWISE SPECIFIED:		NAME	DATE	22 GAUGE		
DIMENSIONS ARE IN INCHES		DRAWN				TITLE: LA-W-12-24W-MBK-A-TBL-30K
TOLERANCES:		CHECKED				
FRACTIONAL ±		ENG APPR.				
ANGULAR: MACH ± BEND ±		MFG APPR.				
TWO PLACE DECIMAL ±		Q.A.		SIZE	DWG. NO.	REV
THREE PLACE DECIMAL ±		COMMENTS:		A		
INTERPRET GEOMETRIC TOLERANCING PER:				SCALE: 1:4	WEIGHT:	SHEET 4 OF 6
MATERIAL						
FINISH						
NEXT ASSY		USED ON				
APPLICATION		DO NOT SCALE DRAWING				

PROPRIETARY AND CONFIDENTIAL
 THE INFORMATION CONTAINED IN THIS DRAWING IS THE SOLE PROPERTY OF <INSERT COMPANY NAME HERE>. ANY REPRODUCTION IN PART OR AS A WHOLE WITHOUT THE WRITTEN PERMISSION OF <INSERT COMPANY NAME HERE> IS PROHIBITED.

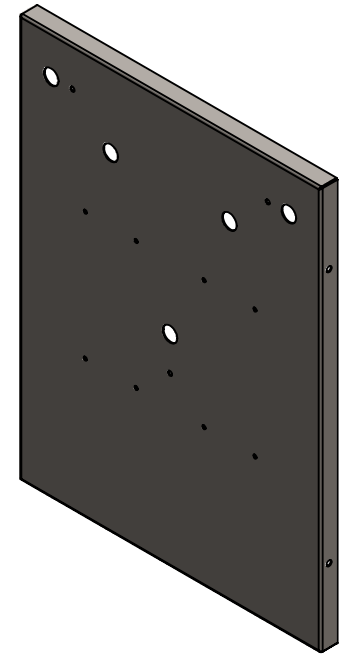
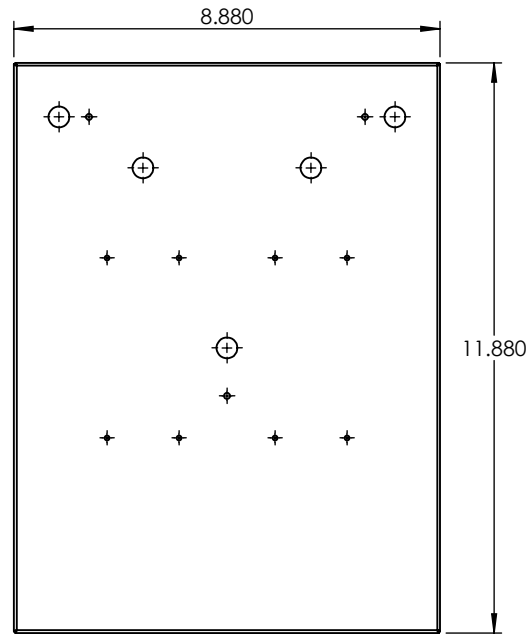
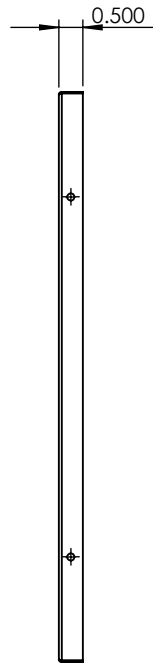
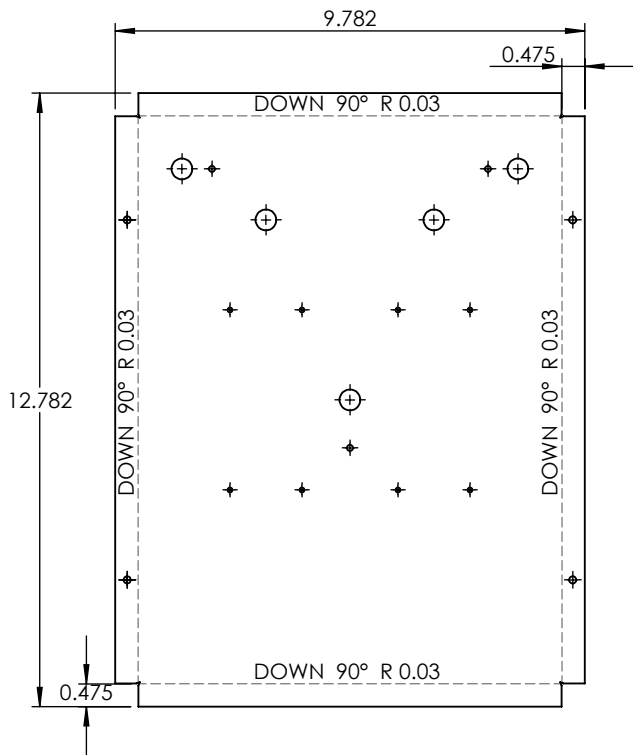

PROPRIETARY AND CONFIDENTIAL
 THE INFORMATION CONTAINED IN THIS DRAWING IS THE SOLE PROPERTY OF <INSERT COMPANY NAME HERE>. ANY REPRODUCTION IN PART OR AS A WHOLE WITHOUT THE WRITTEN PERMISSION OF <INSERT COMPANY NAME HERE> IS PROHIBITED.

		UNLESS OTHERWISE SPECIFIED:		NAME	DATE
		DIMENSIONS ARE IN INCHES	DRAWN		
		TOLERANCES:	CHECKED		
		FRACTIONAL ±	ENG APPR.		
		ANGULAR: MACH ± BEND ±	MFG APPR.		
		TWO PLACE DECIMAL ±	Q.A.		
		THREE PLACE DECIMAL ±	COMMENTS:		
		INTERPRET GEOMETRIC TOLERANCING PER:			
		MATERIAL			
NEXT ASSY	USED ON	FINISH			
APPLICATION		DO NOT SCALE DRAWING			

22 GAUGE		
TITLE:		
LA-W-12-24W-MBK-A-TBL-30K		
SIZE	DWG. NO.	REV
A		
SCALE: 1:4	WEIGHT:	SHEET 5 OF 6

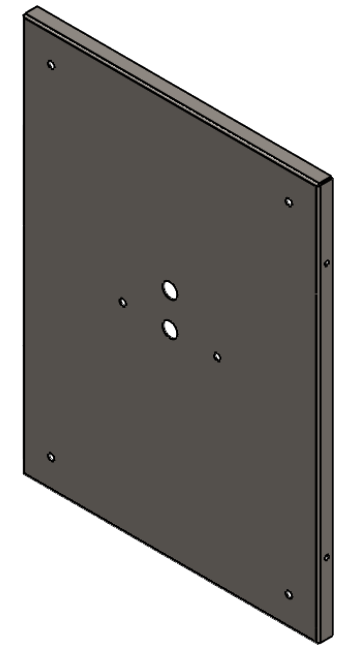
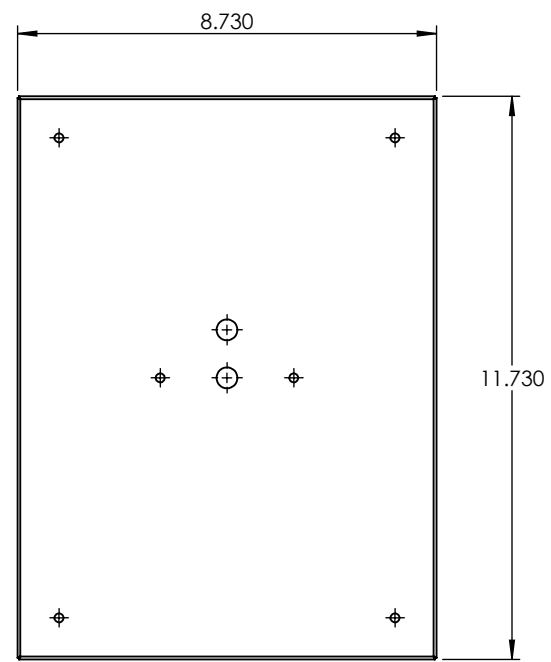
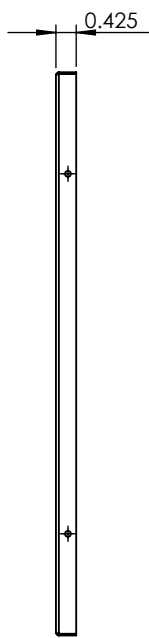
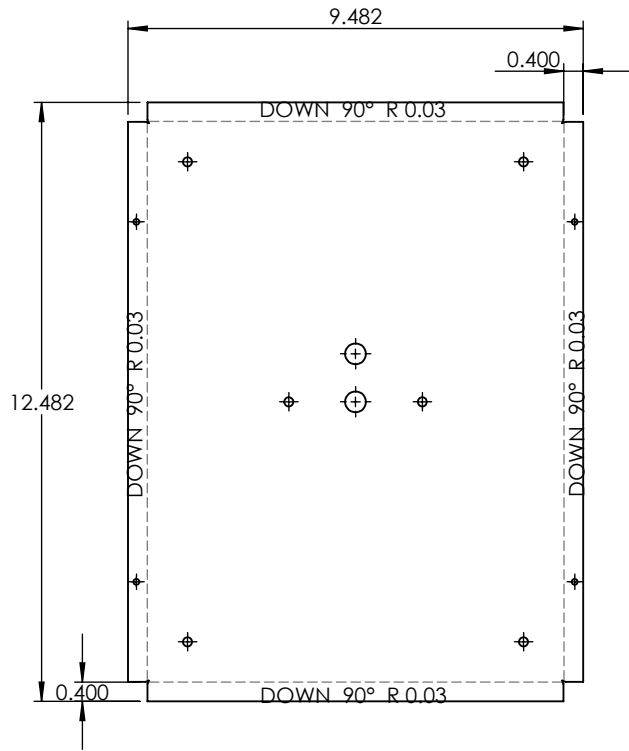

PROPRIETARY AND CONFIDENTIAL
 THE INFORMATION CONTAINED IN THIS DRAWING IS THE SOLE PROPERTY OF <INSERT COMPANY NAME HERE>. ANY REPRODUCTION IN PART OR AS A WHOLE WITHOUT THE WRITTEN PERMISSION OF <INSERT COMPANY NAME HERE> IS PROHIBITED.

		UNLESS OTHERWISE SPECIFIED:		NAME	DATE
		DIMENSIONS ARE IN INCHES	DRAWN		
		TOLERANCES:	CHECKED		
		FRACTIONAL ±	ENG APPR.		
		ANGULAR: MACH ± BEND ±	MFG APPR.		
		TWO PLACE DECIMAL ±	Q.A.		
		THREE PLACE DECIMAL ±	COMMENTS:		
		INTERPRET GEOMETRIC TOLERANCING PER:			
		MATERIAL			
NEXT ASSY	USED ON	FINISH			
APPLICATION		DO NOT SCALE DRAWING			

22 GAUGE		
TITLE:		
LA-W-12-24W-MBK-A-TBL-30K		
SIZE	DWG. NO.	REV
A		
SCALE: 1:4	WEIGHT:	SHEET 6 OF 6

5

4

3

2

1