

ITEM NO.	PART NUMBER	DESCRIPTION	QTY.	CUT
1	WH-W-15-18W-AB-WF-TLBL-EMR-WET-30K-BACKPLATE	22 GAUGE	1	
2	WH-W-15-18W-AB-WF-TLBL-EMR-WET-30K-LED SPACER	22 GAUGE	1	
3	WH-W-15-18W-AB-WF-TLBL-EMR-WET-30K-FIREPLATE	22 GAUGE	1	
4	WH-W-15-18W-AB-WF-TLBL-EMR-WET-30K-LENS RAIL	22 GAUGE	2	
5	WH-W-15-18W-AB-WF-TLBL-EMR-WET-30K-END CAP LENS	22 GAUGE	1	
6	WH-W-15-18W-AB-WF-TLBL-EMR-WET-30K-EMR END CAP	22 GAUGE	1	
7	WH-W-15-18W-AB-WF-TLBL-EMR-WET-30K-ALUMINUM BAR	1/2" SQUARE ALUMINUM BAR	1	
8	WH-W-15-18W-AB-WF-TLBL-EMR-WET-30K-ACRYLIC	ACRYLIC	1	
9	ACE-G10-55-190-EMR PACK	DRIVER-BATTERY	1	
10	EMR BUTTON	BUTTON	1	
11	Espen VEL19070MVH-1	DRIVER	1	
12	AltAILED PN107B-11-SS	LED	2	

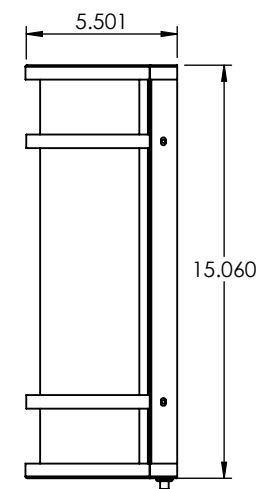
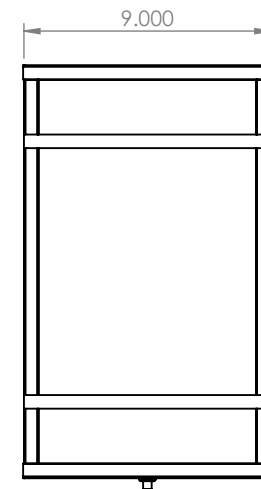
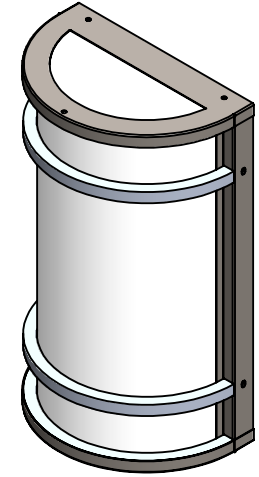
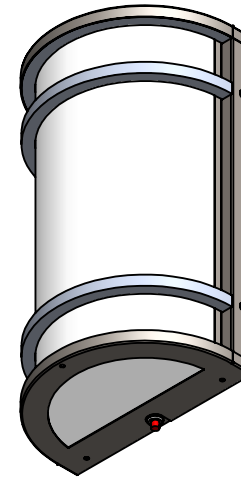
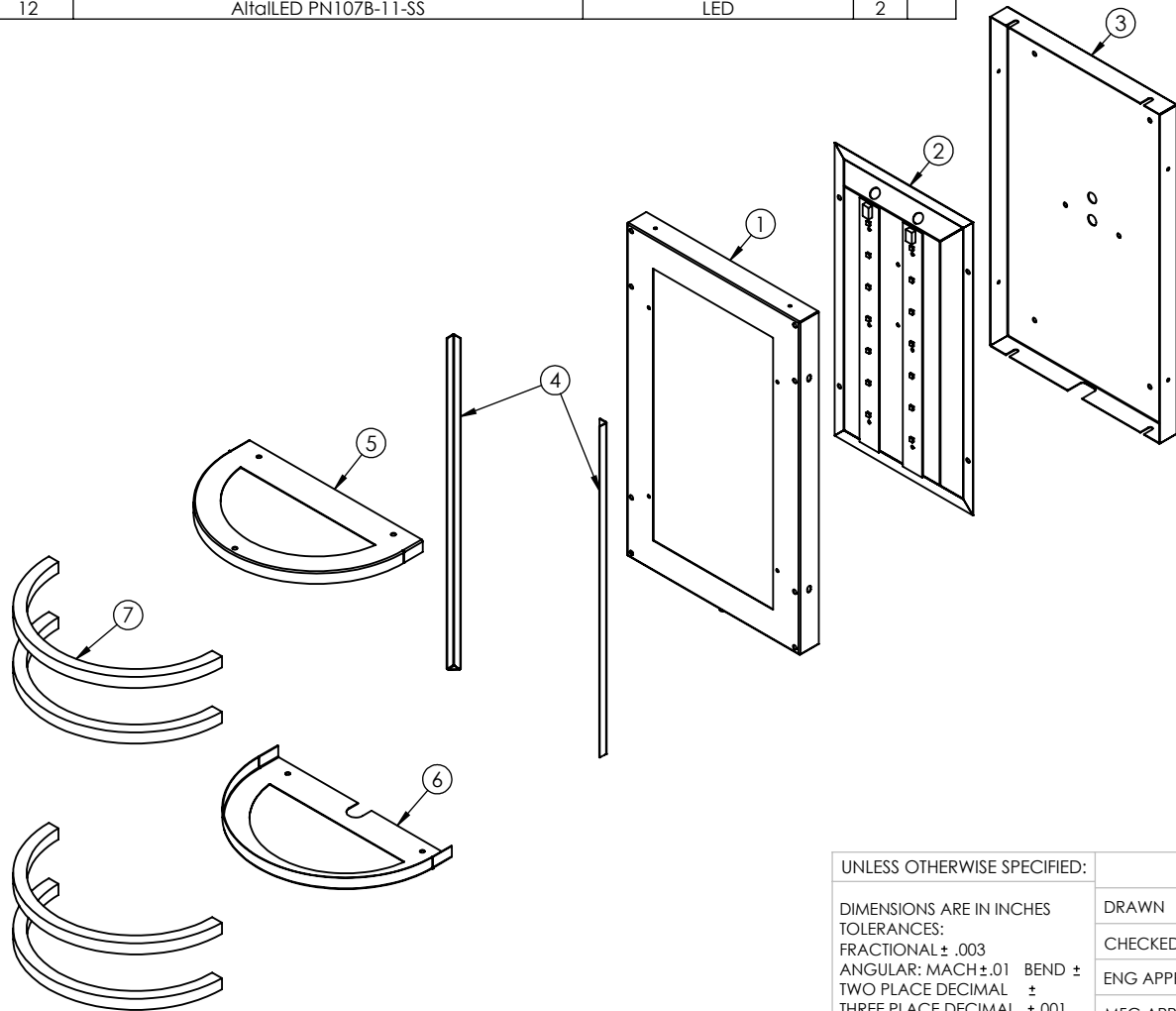

UNLESS OTHERWISE SPECIFIED:

DIMENSIONS ARE IN INCHES  
 TOLERANCES:  
 FRACTIONAL ± .003  
 ANGULAR: MACH ± .01 BEND ±  
 TWO PLACE DECIMAL ±  
 THREE PLACE DECIMAL ±.001

INTERPRET GEOMETRIC  
 TOLERANCING PER:

MATERIAL

FINISH

	NAME	DATE
DRAWN		
CHECKED		
ENG APPR.		
MFG APPR.		
Q.A.		

COMMENTS:

TITLE:

WH-W-15-18W-AB-WF-TLBL-EMR-WET-30K

SIZE	DWG. NO.	REV
<b>A</b>	TICKET 25153	

SCALE: 1:7	WEIGHT:	SHEET 1 OF 7
------------	---------	--------------



ALL BEND RADIUS .030"

APPLICATION

DO NOT SCALE DRAWING

5

4

3

2

1

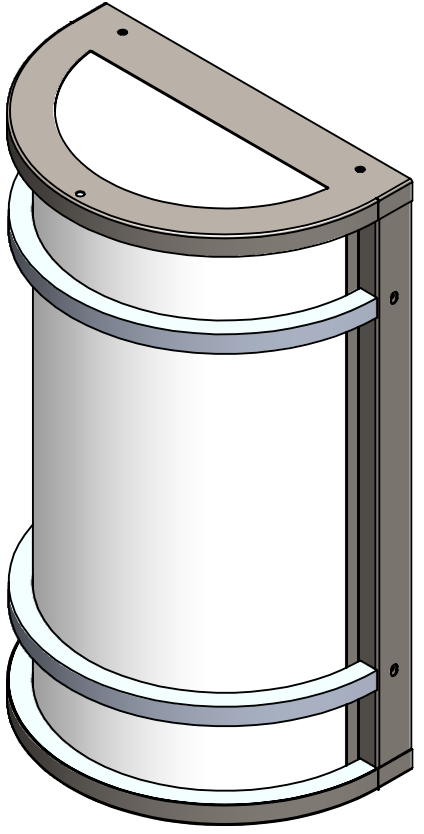
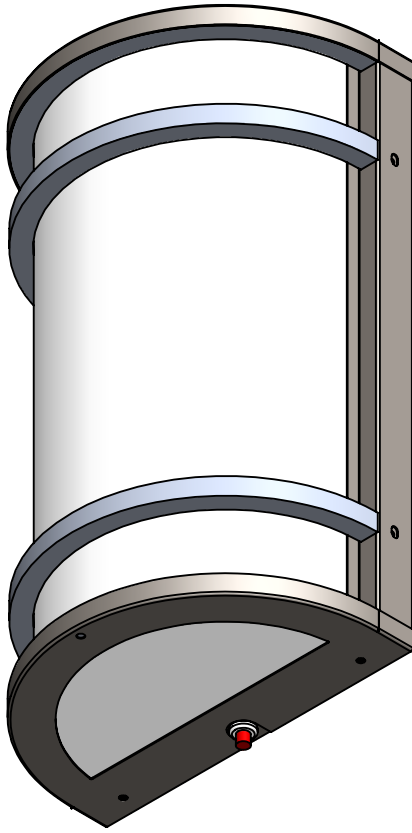
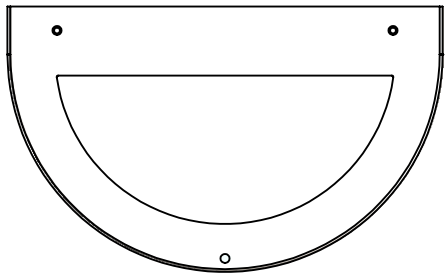
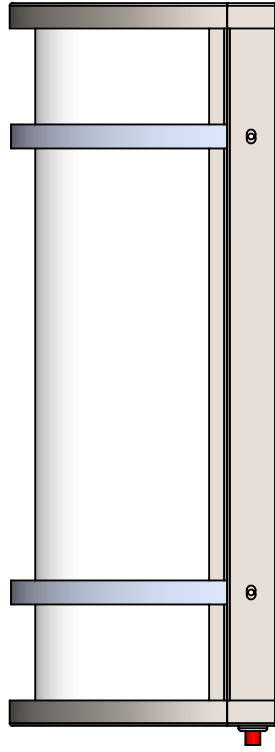
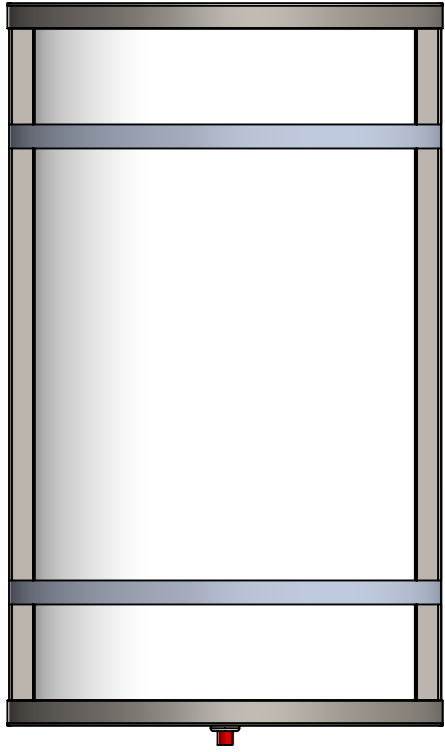

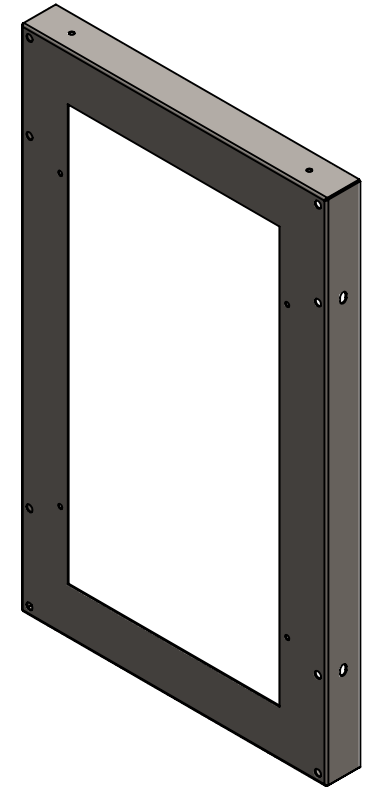
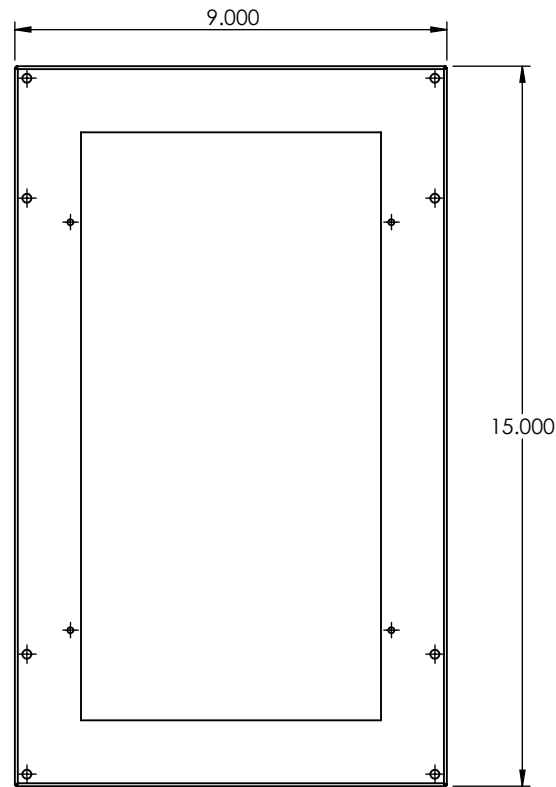
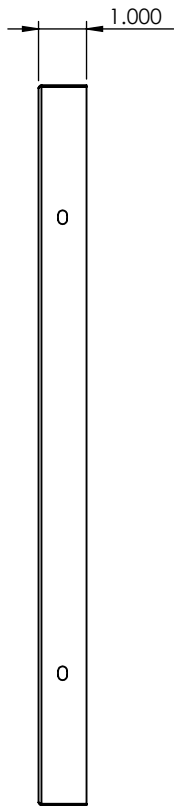
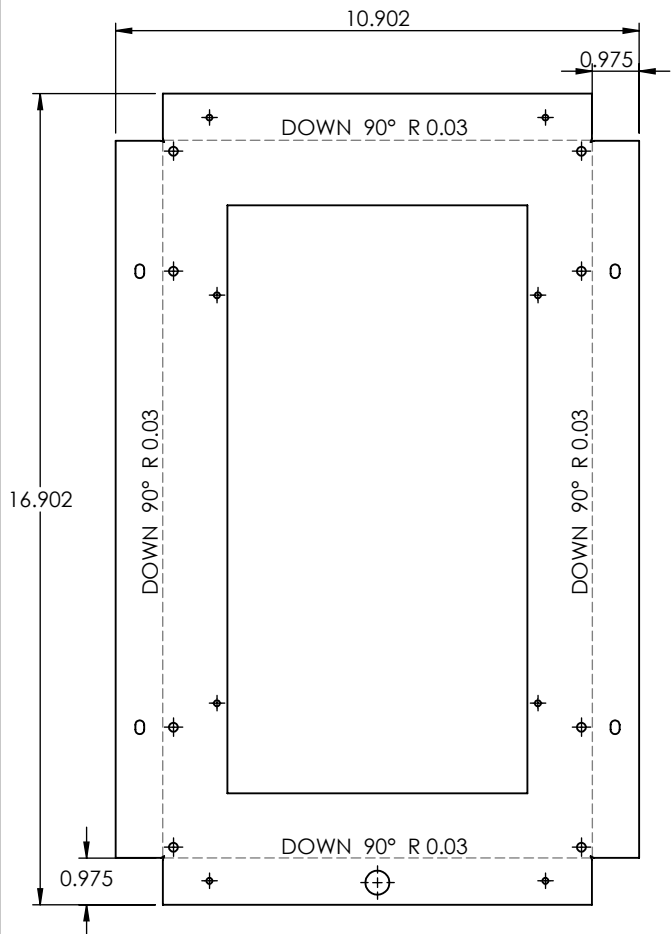

**PROPRIETARY AND CONFIDENTIAL**  
 THE INFORMATION CONTAINED IN THIS DRAWING IS THE SOLE PROPERTY OF <INSERT COMPANY NAME HERE>. ANY REPRODUCTION IN PART OR AS A WHOLE WITHOUT THE WRITTEN PERMISSION OF <INSERT COMPANY NAME HERE> IS PROHIBITED.

		UNLESS OTHERWISE SPECIFIED:		NAME	DATE	22 GAUGE	
		DIMENSIONS ARE IN INCHES	DRAWN			TITLE:	
		TOLERANCES:	CHECKED			WH-W-15-18W-AB-WF-TLBL-EMR-WET-30K	
		FRACTIONAL ±	ENG APPR.			SIZE	DWG. NO.
		ANGULAR: MACH ± BEND ±	MFG APPR.			<b>A</b>	REV
		TWO PLACE DECIMAL ±	Q.A.			SCALE: 1:4	WEIGHT:
		THREE PLACE DECIMAL ±	COMMENTS:				SHEET 3 OF 7
		INTERPRET GEOMETRIC TOLERANCING PER:					
		MATERIAL					
NEXT ASSY	USED ON	FINISH					
APPLICATION		DO NOT SCALE DRAWING					

5

4

3

2

1

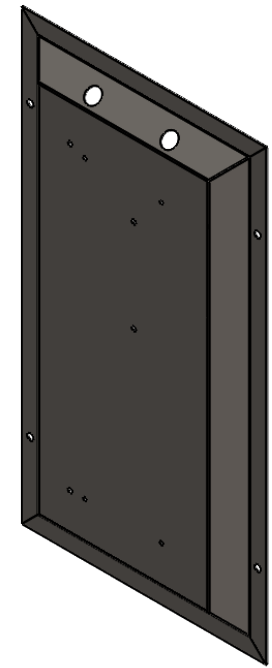
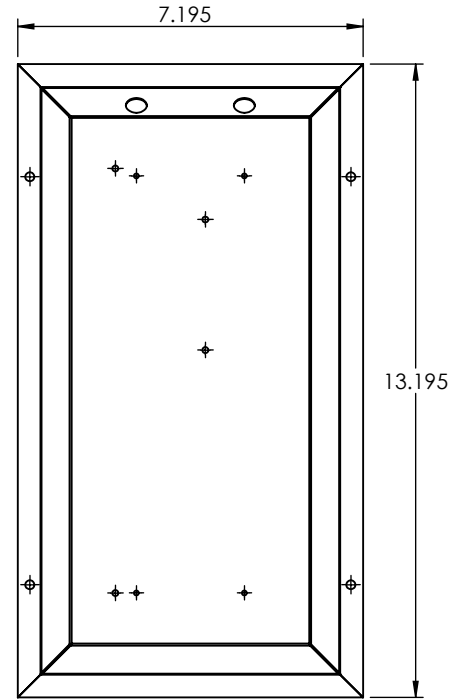
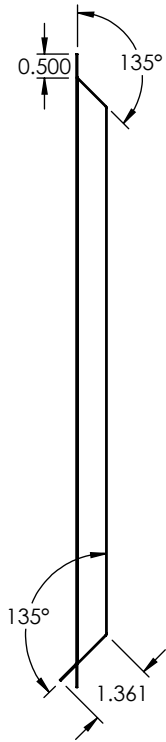
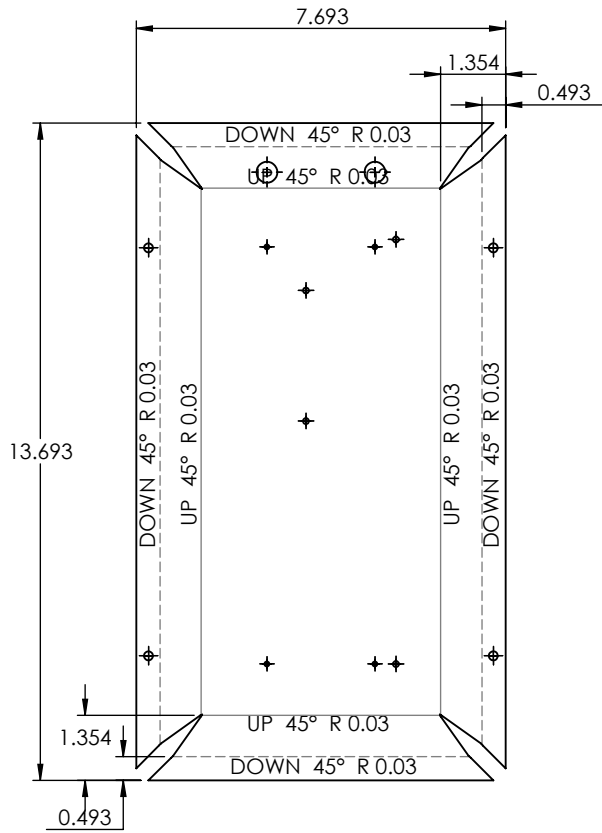

**PROPRIETARY AND CONFIDENTIAL**  
 THE INFORMATION CONTAINED IN THIS DRAWING IS THE SOLE PROPERTY OF <INSERT COMPANY NAME HERE>. ANY REPRODUCTION IN PART OR AS A WHOLE WITHOUT THE WRITTEN PERMISSION OF <INSERT COMPANY NAME HERE> IS PROHIBITED.

		UNLESS OTHERWISE SPECIFIED:	NAME	DATE	22 GAUGE	
		DIMENSIONS ARE IN INCHES	DRAWN		TITLE: WH-W-15-18W-AB-WF-TLBL-EMR-WET-30K	
		TOLERANCES:	CHECKED			
		FRACTIONAL ±	ENG APPR.			
		ANGULAR: MACH ± BEND ±	MFG APPR.			
		TWO PLACE DECIMAL ±	Q.A.		SIZE	DWG. NO.
		THREE PLACE DECIMAL ±	COMMENTS:		<b>A</b>	
		INTERPRET GEOMETRIC TOLERANCING PER:			SCALE: 1:4	WEIGHT:
		MATERIAL				SHEET 4 OF 7
NEXT ASSY	USED ON	FINISH				
APPLICATION		DO NOT SCALE DRAWING				

5

4

3

2

1

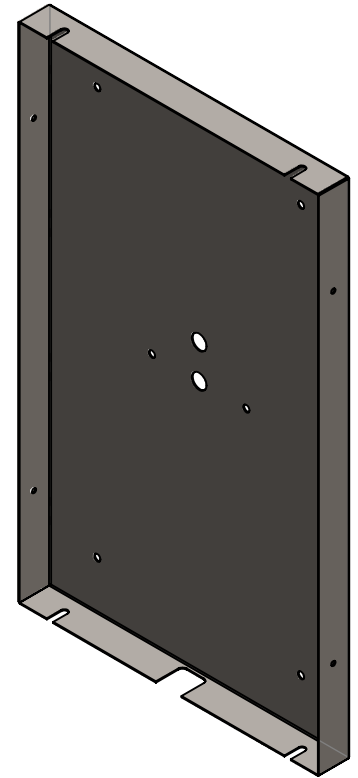
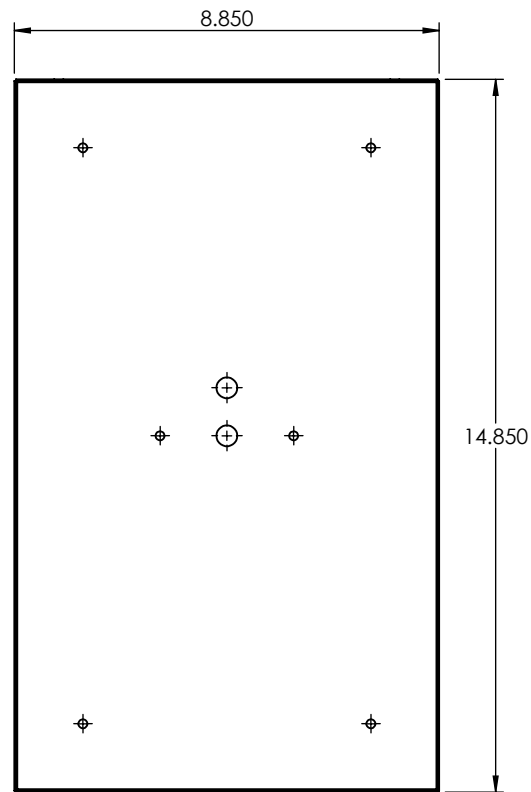
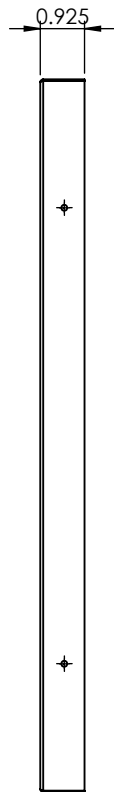
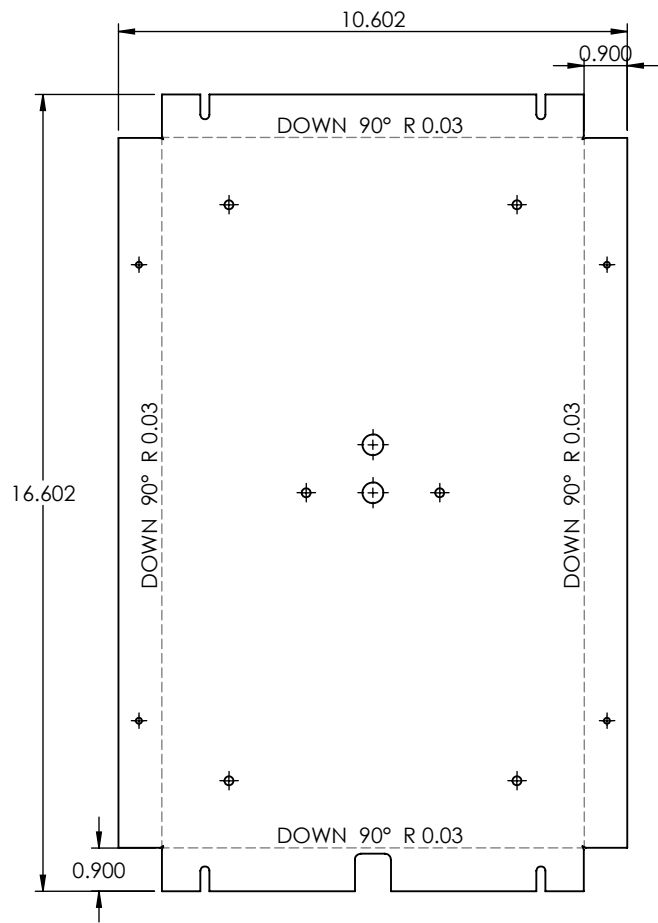

**PROPRIETARY AND CONFIDENTIAL**  
 THE INFORMATION CONTAINED IN THIS DRAWING IS THE SOLE PROPERTY OF <INSERT COMPANY NAME HERE>. ANY REPRODUCTION IN PART OR AS A WHOLE WITHOUT THE WRITTEN PERMISSION OF <INSERT COMPANY NAME HERE> IS PROHIBITED.

		UNLESS OTHERWISE SPECIFIED:	NAME	DATE	22 GAUGE	
		DIMENSIONS ARE IN INCHES	DRAWN		TITLE:	
		TOLERANCES:	CHECKED		WH-W-15-18W-AB-WF-TLBL-EMR-WET-30K	
		FRACTIONAL ±	ENG APPR.		SIZE	DWG. NO.
		ANGULAR: MACH ± BEND ±	MFG APPR.		<b>A</b>	REV
		TWO PLACE DECIMAL ±	Q.A.		SCALE: 1:4	WEIGHT:
		THREE PLACE DECIMAL ±	COMMENTS:			SHEET 5 OF 7
		INTERPRET GEOMETRIC TOLERANCING PER:				
		MATERIAL				
NEXT ASSY	USED ON	FINISH				
APPLICATION		DO NOT SCALE DRAWING				

5

4

3

2

1

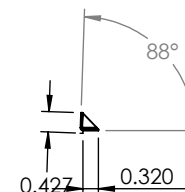
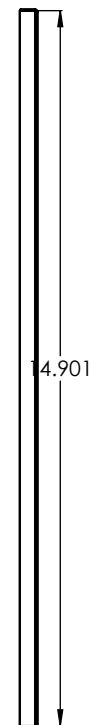
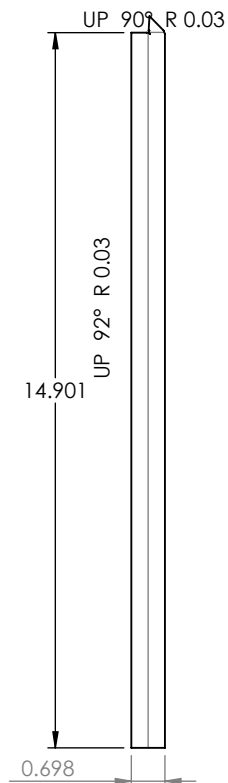
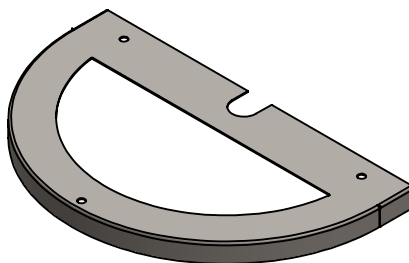
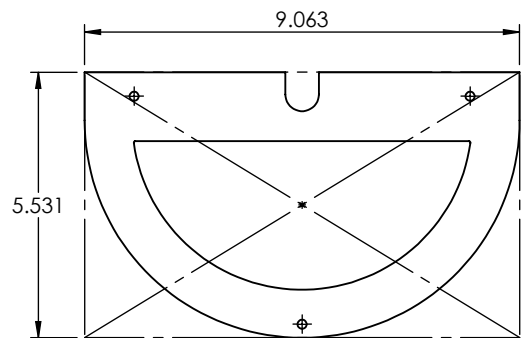
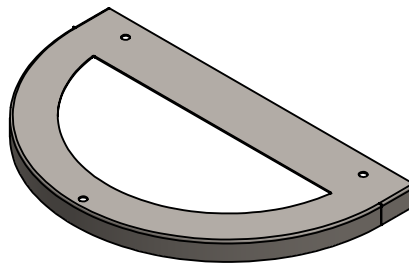
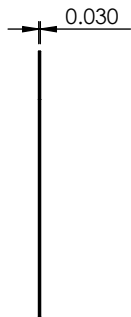
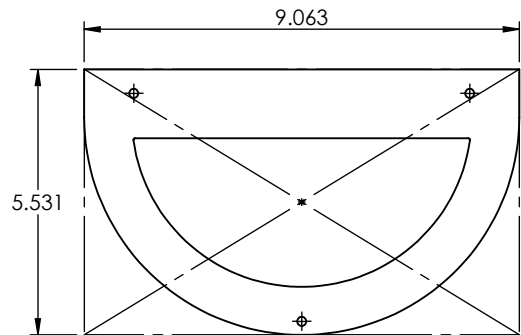

**PROPRIETARY AND CONFIDENTIAL**  
 THE INFORMATION CONTAINED IN THIS DRAWING IS THE SOLE PROPERTY OF <INSERT COMPANY NAME HERE>. ANY REPRODUCTION IN PART OR AS A WHOLE WITHOUT THE WRITTEN PERMISSION OF <INSERT COMPANY NAME HERE> IS PROHIBITED.

		UNLESS OTHERWISE SPECIFIED:	NAME	DATE
		DIMENSIONS ARE IN INCHES	DRAWN	
		TOLERANCES:	CHECKED	
		FRACTIONAL ±	ENG APPR.	
		ANGULAR: MACH ± BEND ±	MFG APPR.	
		TWO PLACE DECIMAL ±	Q.A.	
		THREE PLACE DECIMAL ±	COMMENTS:	
		INTERPRET GEOMETRIC TOLERANCING PER:		
		MATERIAL		
NEXT ASSY	USED ON	FINISH		
APPLICATION		DO NOT SCALE DRAWING		

22 GAUGE

TITLE:  
 WH-W-15-18W-AB-WF-TLBL-EMR-WET-30K

SIZE DWG. NO. REV  
**A**

SCALE: 1:4 WEIGHT: SHEET 6 OF 7

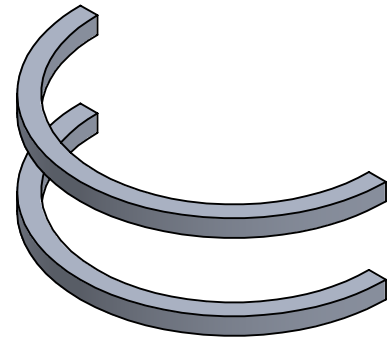
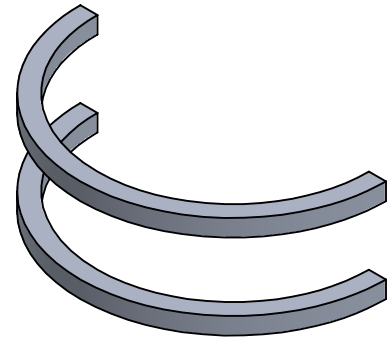
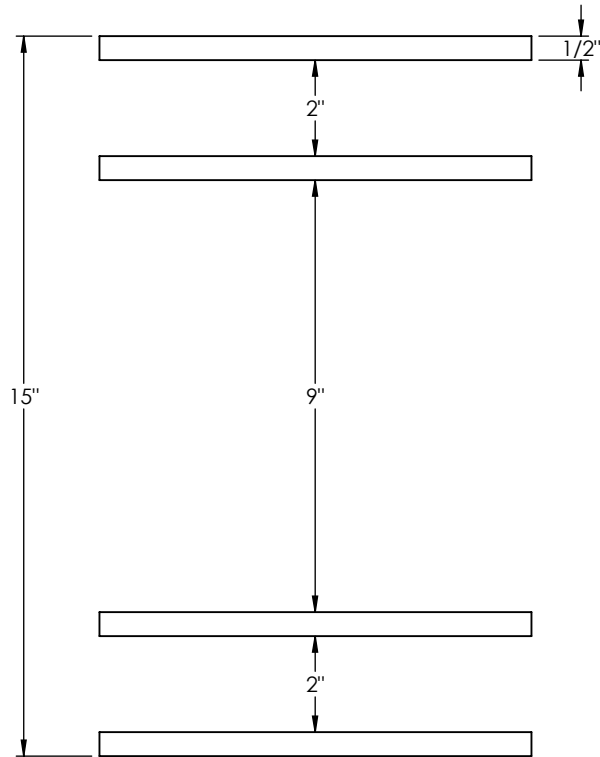
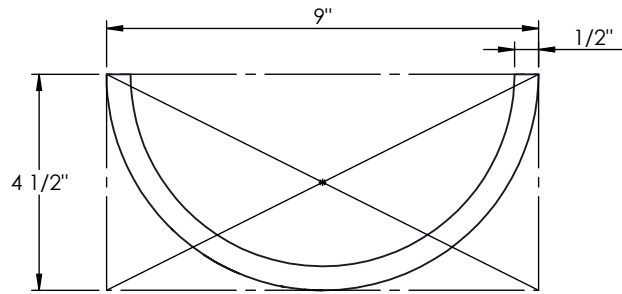

UNLESS OTHERWISE SPECIFIED:		NAME	DATE	1/2" SQUARE ALUMINUM BAR	
DIMENSIONS ARE IN INCHES		DRAWN		TITLE:	
TOLERANCES:		CHECKED		WH-W-15-18W-AB-WF-TLBL-EMR-WET-30K	
FRACTIONAL ±		ENG APPR.		SIZE	DWG. NO.
ANGULAR: MACH ± BEND ±		MFG APPR.		<b>A</b>	REV
TWO PLACE DECIMAL ±		Q.A.		SCALE: 1:4 WEIGHT: SHEET 7 OF 7	
THREE PLACE DECIMAL ±		COMMENTS:			
INTERPRET GEOMETRIC TOLERANCING PER:					
MATERIAL					
FINISH					
APPLICATION					
DO NOT SCALE DRAWING					

**PROPRIETARY AND CONFIDENTIAL**  
 THE INFORMATION CONTAINED IN THIS DRAWING IS THE SOLE PROPERTY OF <INSERT COMPANY NAME HERE>. ANY REPRODUCTION IN PART OR AS A WHOLE WITHOUT THE WRITTEN PERMISSION OF <INSERT COMPANY NAME HERE> IS PROHIBITED.

NEXT ASSY	USED ON
APPLICATION	