

| ITEM NO. | PART NUMBER                              | DESCRIPTION | QTY. | CUT |
|----------|--|-------------|------|-----|
| 1        | 101320LS-MBK-A-II-27K-PYRAMID CAP        | 22 GAUGE    | 1    |     |
| 2        | 101320LS-MBK-A-II-27K-PYRAMID CAP FLANGE | 22 GAUGE    | 2    |     |
| 3        | 101320LS-MBK-A-II-27K-FRAME              | 22 GAUGE    | 1    |     |
| 4        | 101204Q-TBR-A-II-CAP TOP                 | 22 GAUGE    | 1    |     |
| 5        | 101320LS-MBK-A-II-27K-CAP BOTTOM         | 22 GAUGE    | 1    |     |
| 6        | 101320LS-MBK-A-II-27K-BACKPLATE          | 22 GAUGE    | 1    |     |
| 7        | 101320LS-MBK-A-II-27K-DRIVER BRACKET     | 22 GAUGE    | 1    |     |
| 8        | 101320LS-MBK-A-II-27K-ACRYLIC            | ACRYLIC     | 1    |     |
| 11       | Espen VEL19070MVH-1                      | DRIVER      | 1    |     |
| 12       | AItailed_PN1011_RevB                     | LED         | 4    |     |

UNLESS OTHERWISE SPECIFIED:

DIMENSIONS ARE IN INCHES  
 TOLERANCES:  
 FRACTIONAL ± .003  
 ANGULAR: MACH ± .01 BEND ±  
 TWO PLACE DECIMAL ±  
 THREE PLACE DECIMAL ±.001

INTERPRET GEOMETRIC  
 TOLERANCING PER:

MATERIAL

FINISH

|           | NAME | DATE |
|-----------|------|------|
| DRAWN     |      |      |
| CHECKED   |      |      |
| ENG APPR. |      |      |
| MFG APPR. |      |      |
| Q.A.      |      |      |

COMMENTS:

TITLE:

101320LS-MBK-A-II-27K

| SIZE     | DWG. NO.     | REV |
|----------|--------------|-----|
| <b>A</b> | TICKET 25085 |     |

SCALE: 1:6 WEIGHT: SHEET 1 OF 6



ALL BEND RADIUS .030"

APPLICATION

DO NOT SCALE DRAWING

5

4

3

2

1

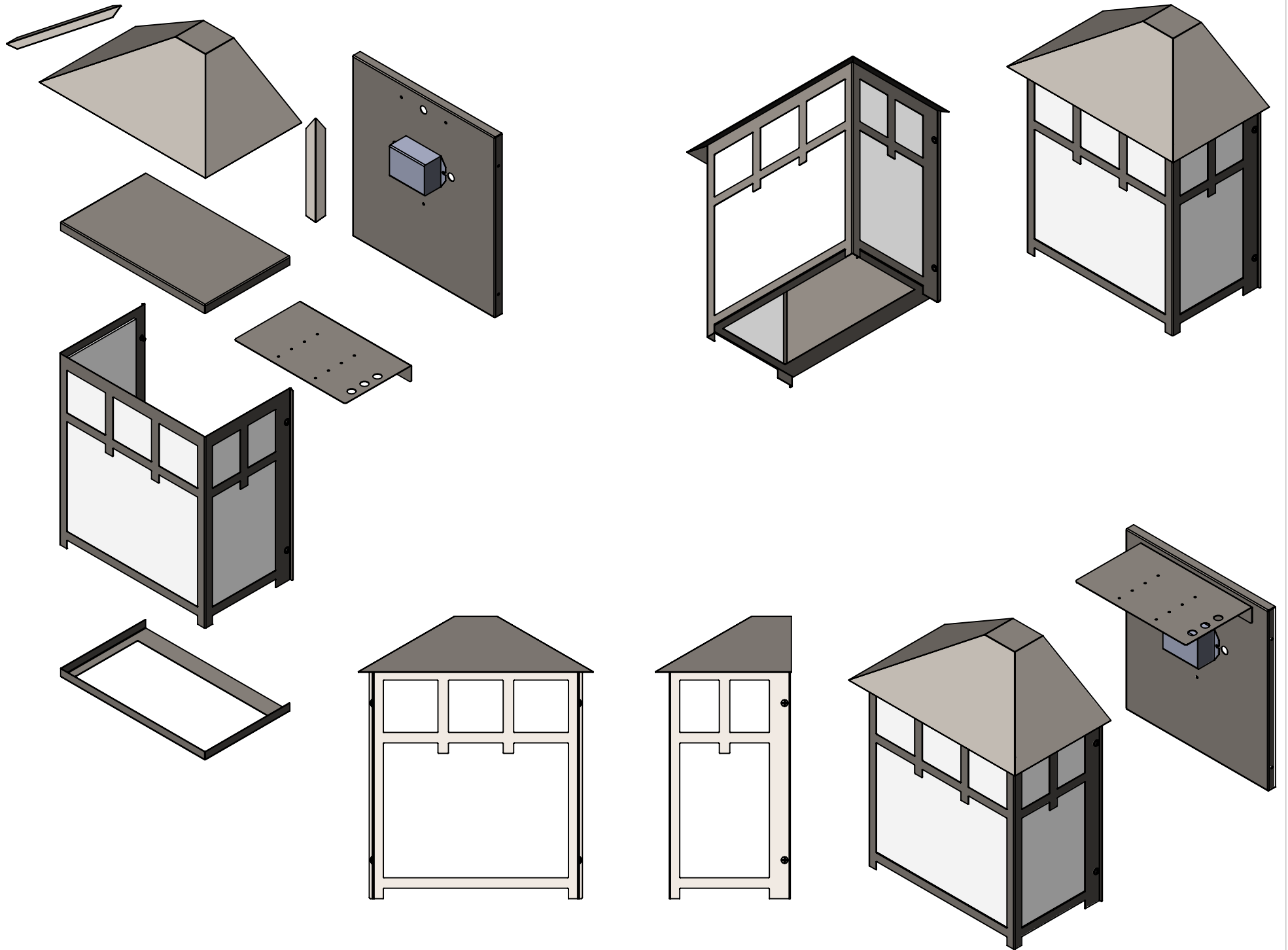

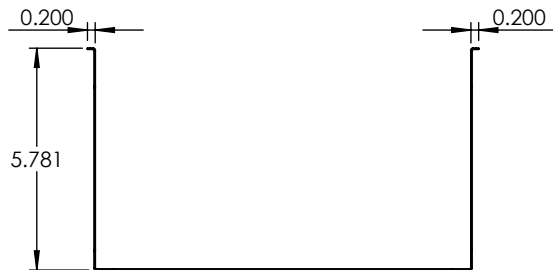
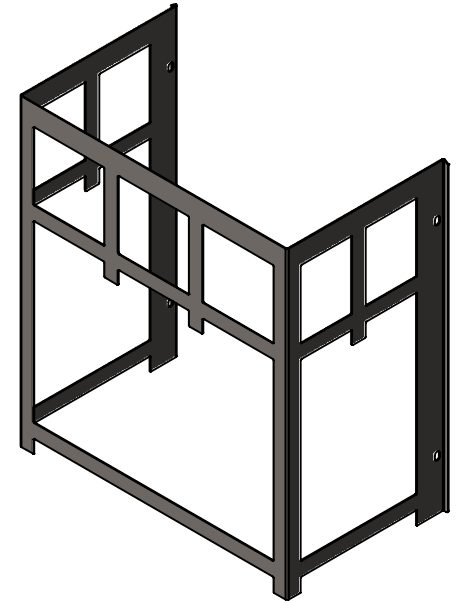
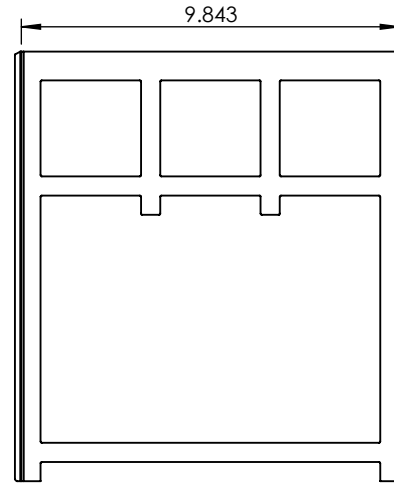
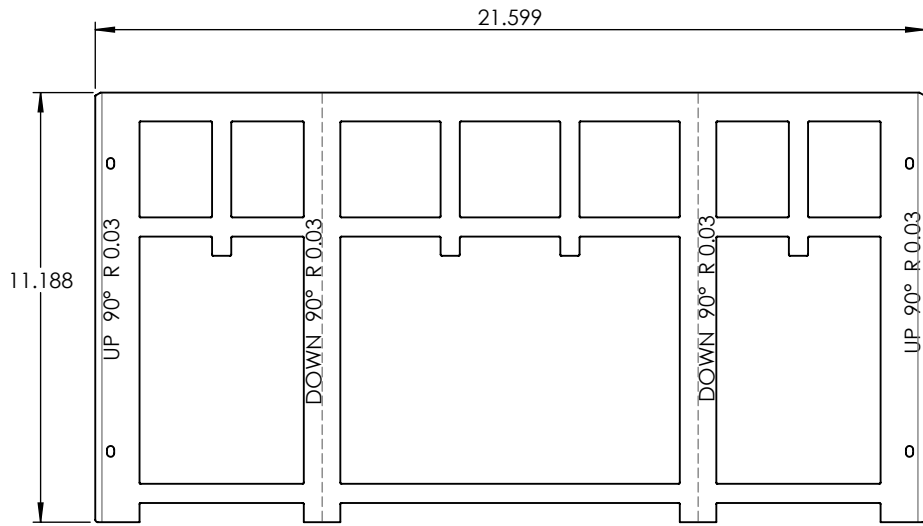

**PROPRIETARY AND CONFIDENTIAL**  
 THE INFORMATION CONTAINED IN THIS DRAWING IS THE SOLE PROPERTY OF <INSERT COMPANY NAME HERE>. ANY REPRODUCTION IN PART OR AS A WHOLE WITHOUT THE WRITTEN PERMISSION OF <INSERT COMPANY NAME HERE> IS PROHIBITED.

|             |         |
|-------------|---------|
|             |         |
| NEXT ASSY   | USED ON |
| APPLICATION |         |

|                                      |
|--------------------------------------|
| UNLESS OTHERWISE SPECIFIED:          |
| DIMENSIONS ARE IN INCHES             |
| TOLERANCES:                          |
| FRACTIONAL ±                         |
| ANGULAR: MACH ± BEND ±               |
| TWO PLACE DECIMAL ±                  |
| THREE PLACE DECIMAL ±                |
| INTERPRET GEOMETRIC TOLERANCING PER: |
| MATERIAL                             |
| FINISH                               |
| DO NOT SCALE DRAWING                 |

|           |      |      |
|-----------|------|------|
|           | NAME | DATE |
| DRAWN     |      |      |
| CHECKED   |      |      |
| ENG APPR. |      |      |
| MFG APPR. |      |      |
| Q.A.      |      |      |
| COMMENTS: |      |      |

|                       |          |              |
|-----------------------|----------|--------------|
| 22 GAUGE              |          |              |
| TITLE:                |          |              |
| 101320LS-MBK-A-II-27K |          |              |
| SIZE                  | DWG. NO. | REV          |
| <b>A</b>              |          |              |
| SCALE: 1:5            | WEIGHT:  | SHEET 3 OF 6 |

5

4

3

2

1

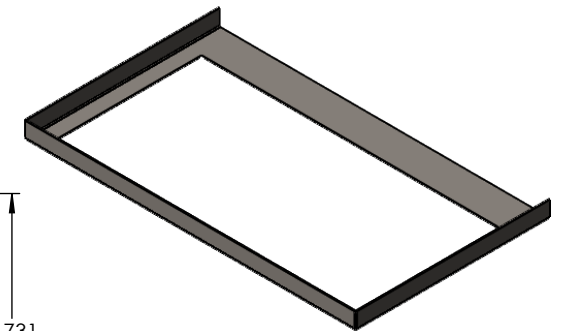
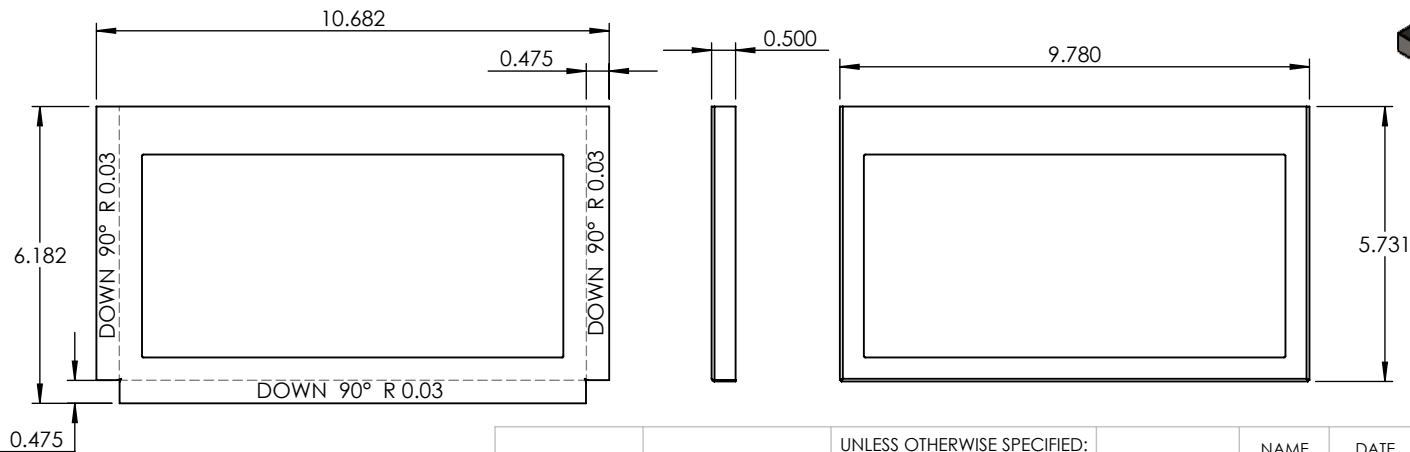
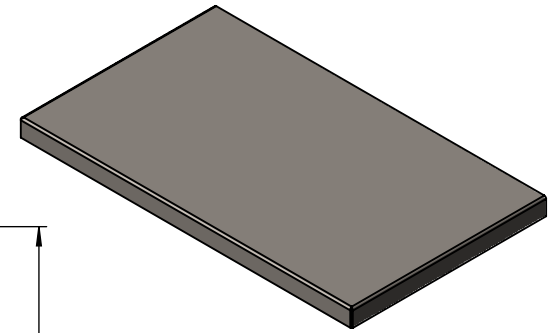
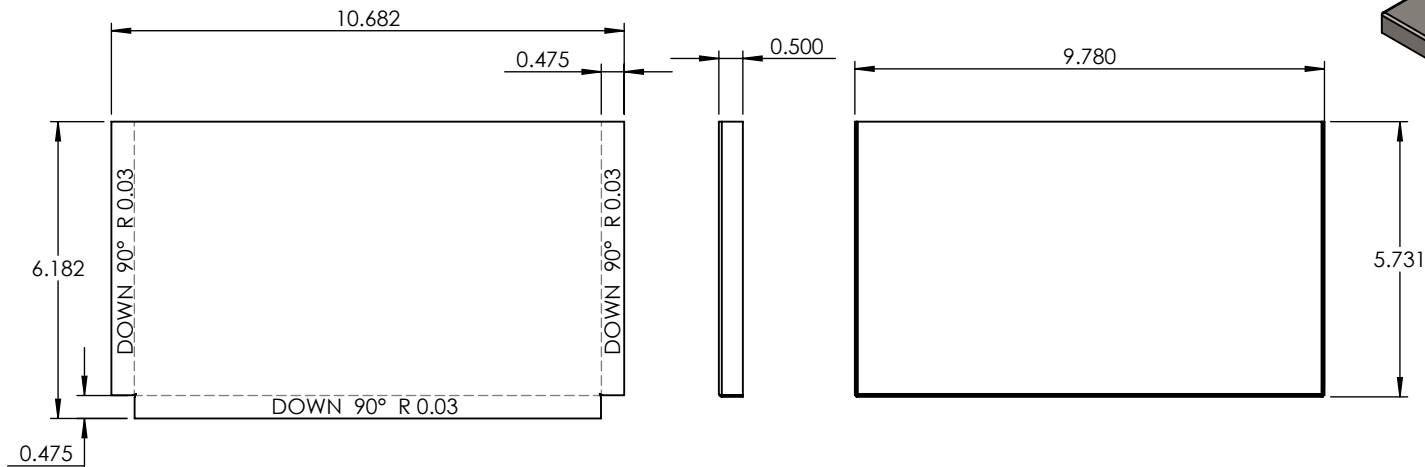

**PROPRIETARY AND CONFIDENTIAL**  
 THE INFORMATION CONTAINED IN THIS DRAWING IS THE SOLE PROPERTY OF <INSERT COMPANY NAME HERE>. ANY REPRODUCTION IN PART OR AS A WHOLE WITHOUT THE WRITTEN PERMISSION OF <INSERT COMPANY NAME HERE> IS PROHIBITED.

|  |             |                                      |           |      |
|--|-------------|--------------------------------------|-----------|------|
|  |             | UNLESS OTHERWISE SPECIFIED:          | NAME      | DATE |
|  |             | DIMENSIONS ARE IN INCHES             | DRAWN     |      |
|  |             | TOLERANCES:                          | CHECKED   |      |
|  |             | FRACTIONAL ±                         | ENG APPR. |      |
|  |             | ANGULAR: MACH ± BEND ±               | MFG APPR. |      |
|  |             | TWO PLACE DECIMAL ±                  | Q.A.      |      |
|  |             | THREE PLACE DECIMAL ±                | COMMENTS: |      |
|  |             | INTERPRET GEOMETRIC TOLERANCING PER: |           |      |
|  |             | MATERIAL                             |           |      |
|  | NEXT ASSY   | USED ON                              |           |      |
|  |             | FINISH                               |           |      |
|  | APPLICATION | DO NOT SCALE DRAWING                 |           |      |

|                                 |          |              |
|---------------------------------|----------|--------------|
| 22 GAUGE                        |          |              |
| TITLE:<br>101320LS-MBK-A-II-27K |          |              |
| SIZE<br><b>A</b>                | DWG. NO. | REV          |
| SCALE: 1:4                      | WEIGHT:  | SHEET 4 OF 6 |

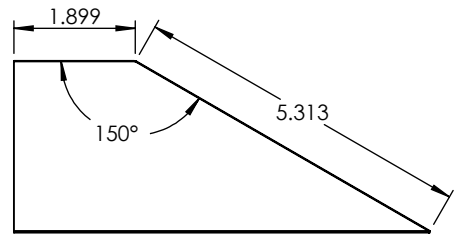
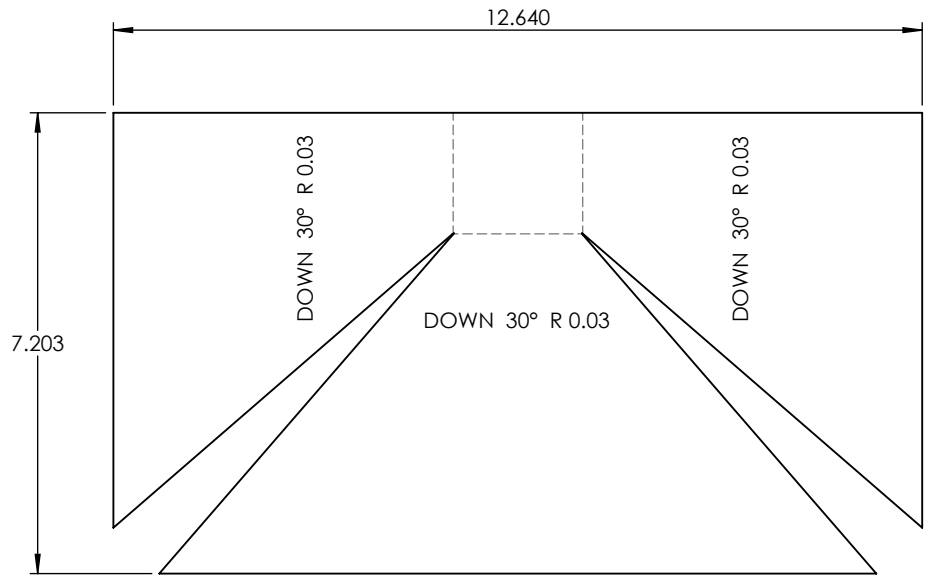
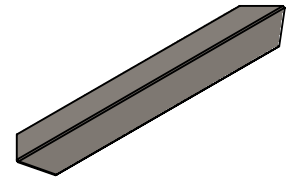
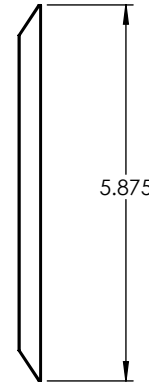
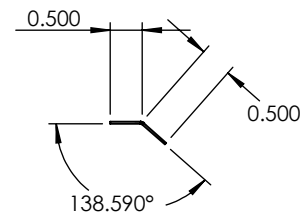
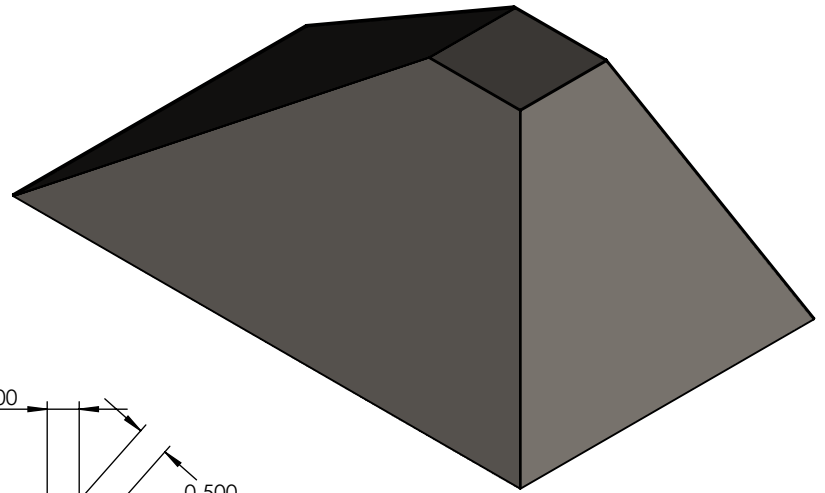

**PROPRIETARY AND CONFIDENTIAL**  
 THE INFORMATION CONTAINED IN THIS DRAWING IS THE SOLE PROPERTY OF <INSERT COMPANY NAME HERE>. ANY REPRODUCTION IN PART OR AS A WHOLE WITHOUT THE WRITTEN PERMISSION OF <INSERT COMPANY NAME HERE> IS PROHIBITED.

|             |         |                                      |           |      |      |
|-------------|---------|--------------------------------------|-----------|------|------|
|             |         | UNLESS OTHERWISE SPECIFIED:          |           | NAME | DATE |
|             |         | DIMENSIONS ARE IN INCHES             | DRAWN     |      |      |
|             |         | TOLERANCES:                          | CHECKED   |      |      |
|             |         | FRACTIONAL ±                         | ENG APPR. |      |      |
|             |         | ANGULAR: MACH ± BEND ±               | MFG APPR. |      |      |
|             |         | TWO PLACE DECIMAL ±                  | Q.A.      |      |      |
|             |         | THREE PLACE DECIMAL ±                | COMMENTS: |      |      |
|             |         | INTERPRET GEOMETRIC TOLERANCING PER: |           |      |      |
|             |         | MATERIAL                             |           |      |      |
| NEXT ASSY   | USED ON | FINISH                               |           |      |      |
| APPLICATION |         | DO NOT SCALE DRAWING                 |           |      |      |

|                                 |          |              |
|---------------------------------|----------|--------------|
| 22 GAUGE                        |          |              |
| TITLE:<br>101320LS-MBK-A-II-27K |          |              |
| SIZE<br><b>A</b>                | DWG. NO. | REV          |
| SCALE: 1:3                      | WEIGHT:  | SHEET 5 OF 6 |

5

4

3

2

1

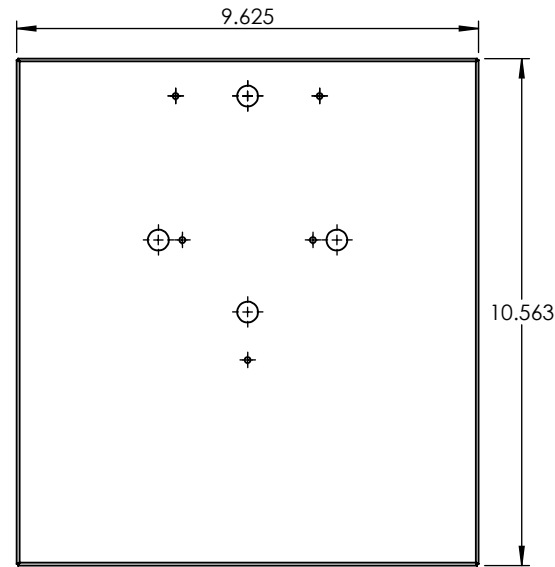
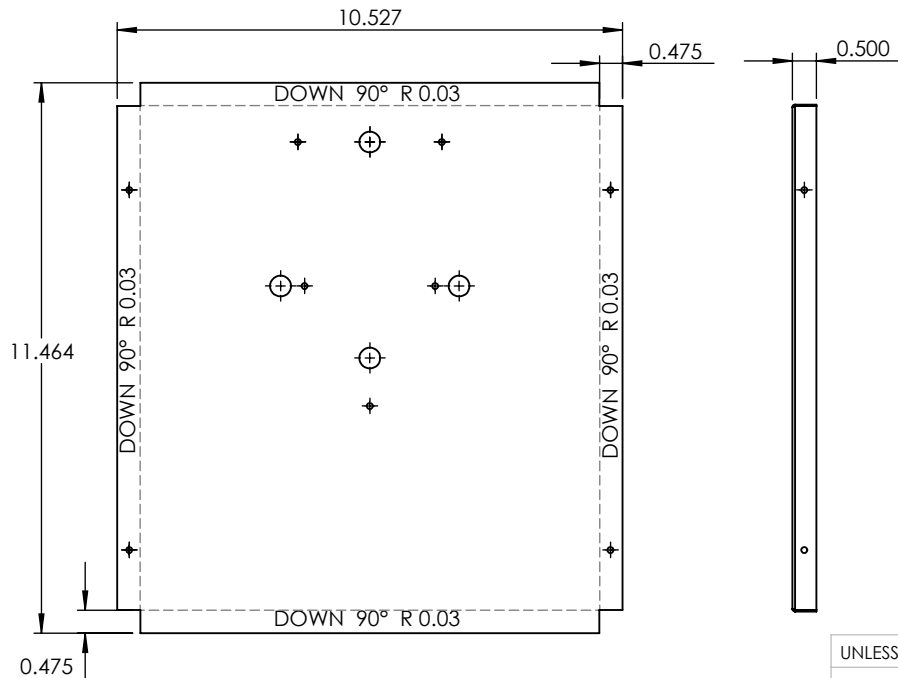
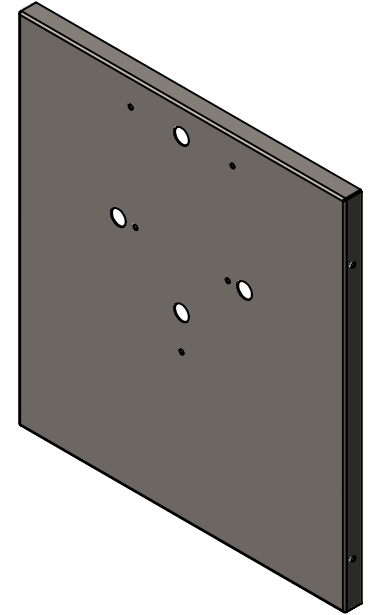
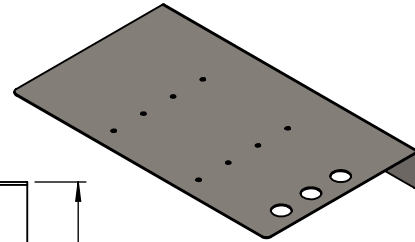
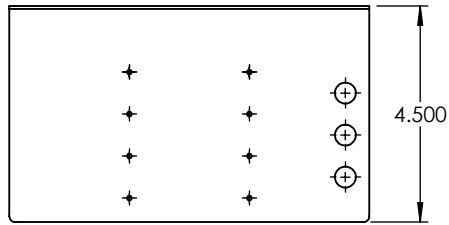
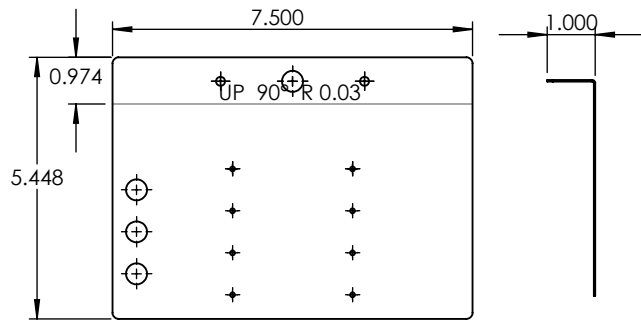

UNLESS OTHERWISE SPECIFIED:

DIMENSIONS ARE IN INCHES  
 TOLERANCES:  
 FRACTIONAL ±  
 ANGULAR: MACH ± BEND ±  
 TWO PLACE DECIMAL ±  
 THREE PLACE DECIMAL ±

INTERPRET GEOMETRIC  
 TOLERANCING PER:

MATERIAL

FINISH

DO NOT SCALE DRAWING

NAME DATE

DRAWN

CHECKED

ENG APPR.

MFG APPR.

Q.A.

COMMENTS:

22 GAUGE

TITLE:

101320LS-MBK-A-II-27K

SIZE DWG. NO.

REV

SCALE: 1:4

WEIGHT:

SHEET 6 OF 6

**PROPRIETARY AND CONFIDENTIAL**  
 THE INFORMATION CONTAINED IN THIS  
 DRAWING IS THE SOLE PROPERTY OF  
 <INSERT COMPANY NAME HERE>. ANY  
 REPRODUCTION IN PART OR AS A WHOLE  
 WITHOUT THE WRITTEN PERMISSION OF  
 <INSERT COMPANY NAME HERE> IS  
 PROHIBITED.

NEXT ASSY

USED ON

APPLICATION