

ITEM NO.	PART NUMBER	DESCRIPTION	QTY.	CUT
1	801209LS-MBK-A-EE-30K-BACKPLATE	22 GAUGE	1	
2	801209LS-MBK-A-EE-30K-DRIVER BRACKET	22 GAUGE	1	
3	801209LS-MBK-A-EE-30K-FRAME	22 GAUGE	1	
4	801209LS-MBK-A-EE-30K-JOINT	22 GAUGE	2	
5	801209LS-MBK-A-EE-30K-TOP CAP	22 GAUGE	1	
6	801209LS-MBK-A-EE-30K-BOTTOM CAP	22 GAUGE	1	
7	801209LS-MBK-A-EE-30K-ACRYLIC	ACRYLIC	1	
8	AltaLED_PN1019_SHIM PLATE	ALUMINUM 0.125" PLATE	1	
9	EspenTECH_120277V_SKU808076	DRIVER	1	
10	AltaLED_PN1019_RevC	LED	1	

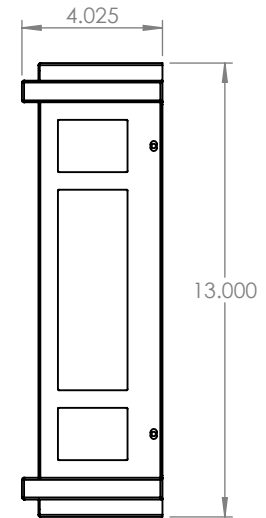
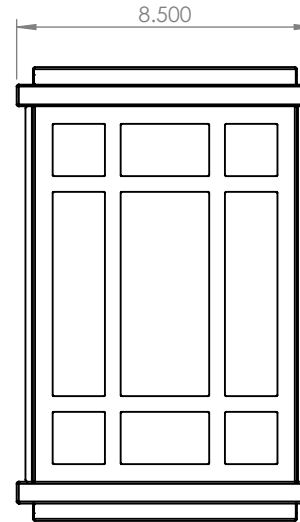
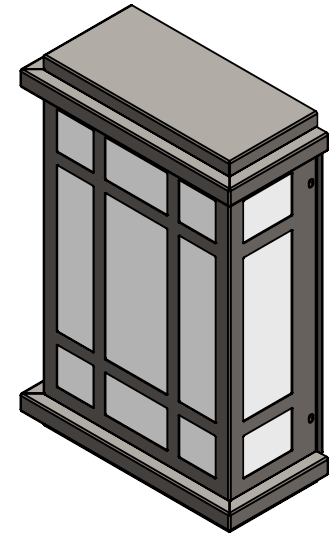
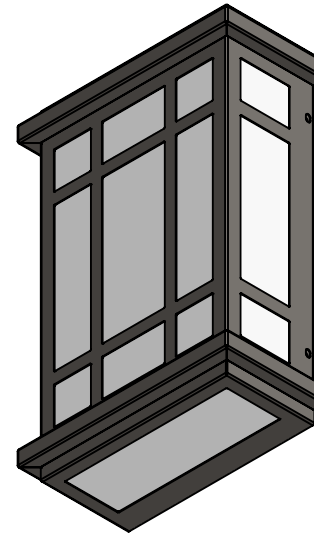
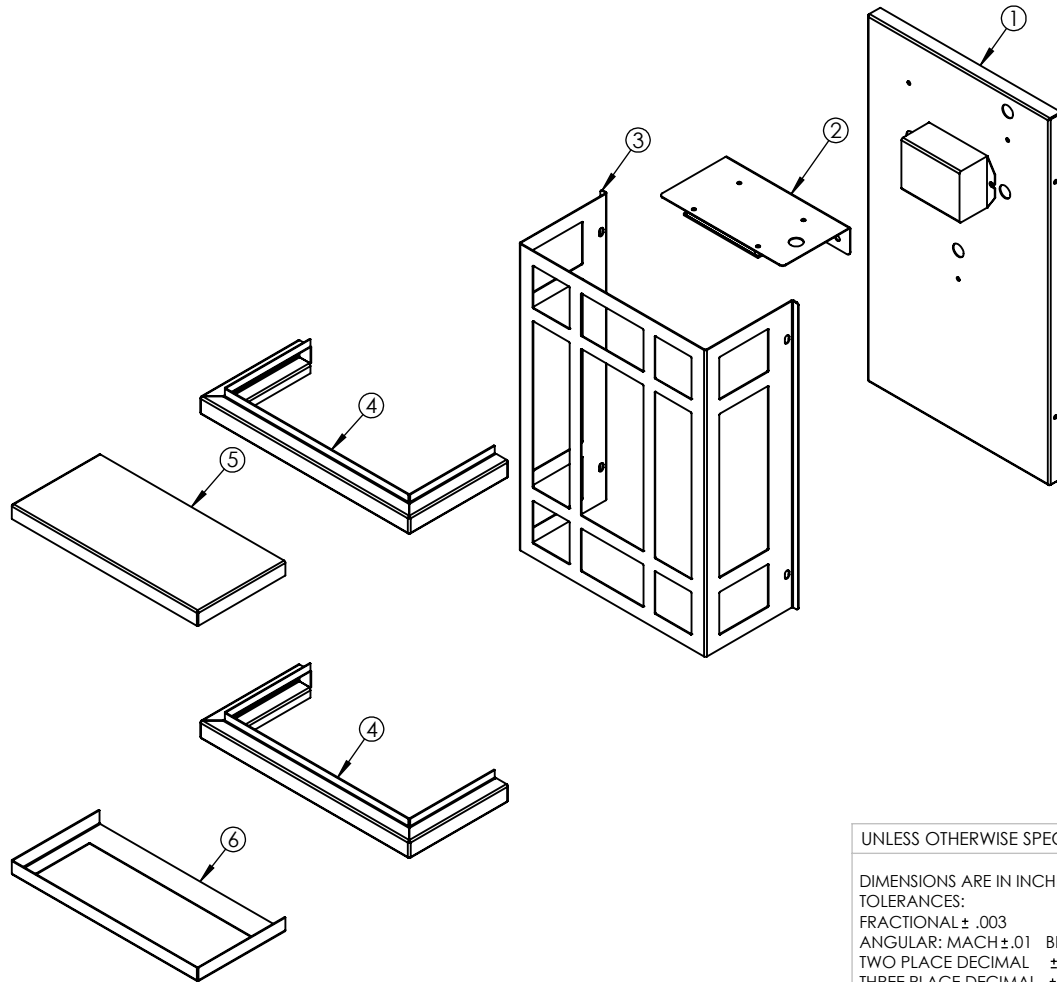

ALL BEND RADIUS .030"

UNLESS OTHERWISE SPECIFIED:

DIMENSIONS ARE IN INCHES
 TOLERANCES:
 FRACTIONAL ± .003
 ANGULAR: MACH ± .01 BEND ±
 TWO PLACE DECIMAL ±
 THREE PLACE DECIMAL ±.001

INTERPRET GEOMETRIC
 TOLERANCING PER:

MATERIAL

FINISH

	NAME	DATE
DRAWN		
CHECKED		
ENG APPR.		
MFG APPR.		
Q.A.		
COMMENTS:		

TITLE:

801209LS-MBK-A-EE-30K

SIZE	DWG. NO.	REV
A	TICKET 25134	
SCALE: 1:5.5	WEIGHT:	SHEET 1 OF 7

5

4

3

2

1

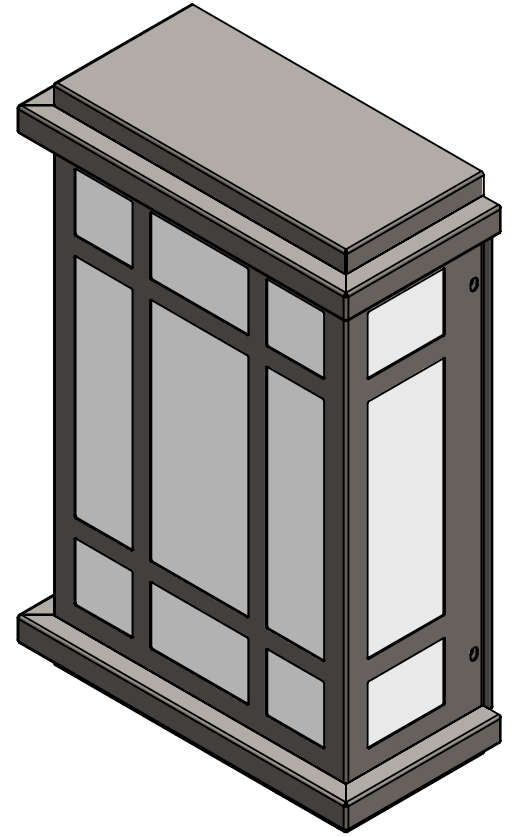
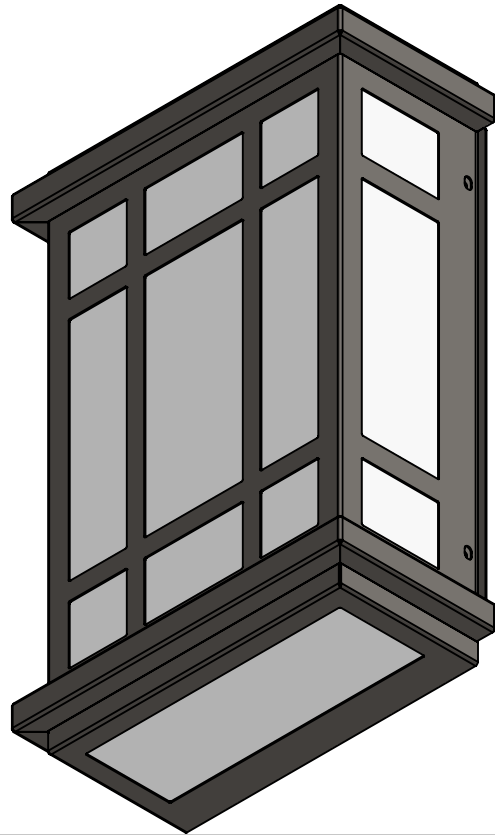
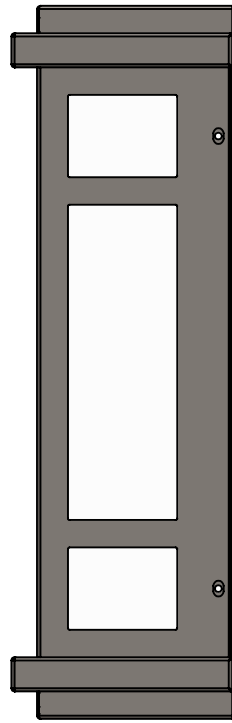
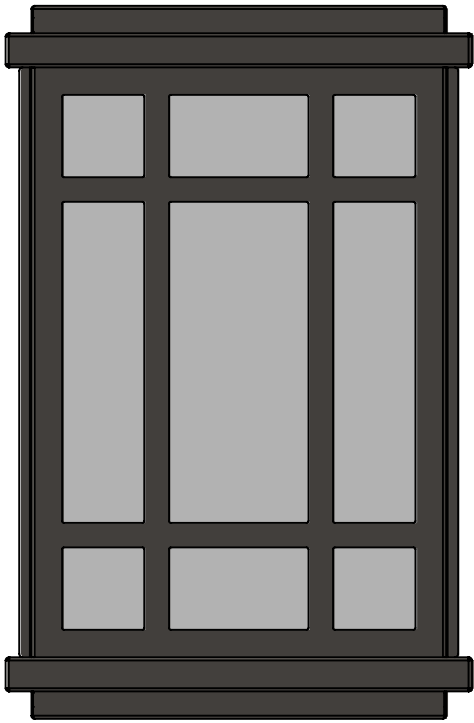

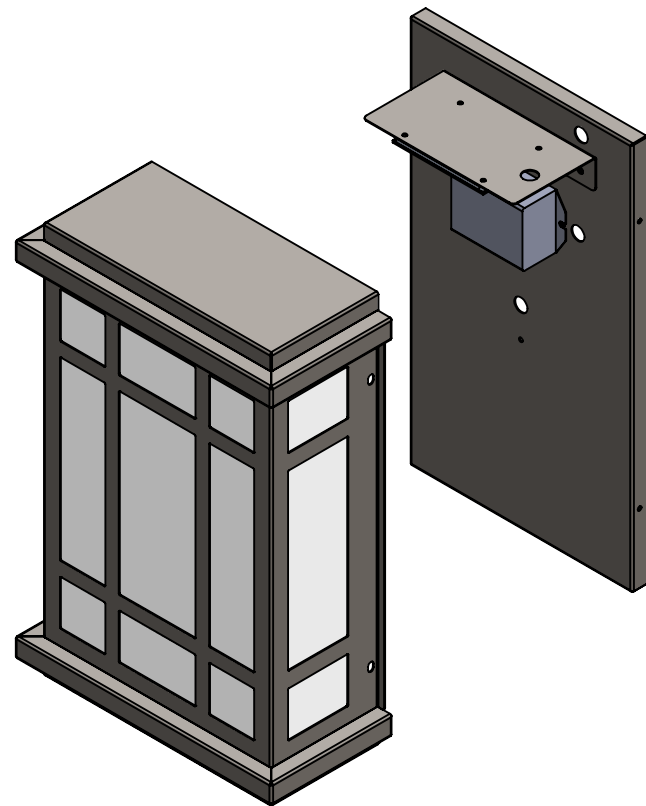
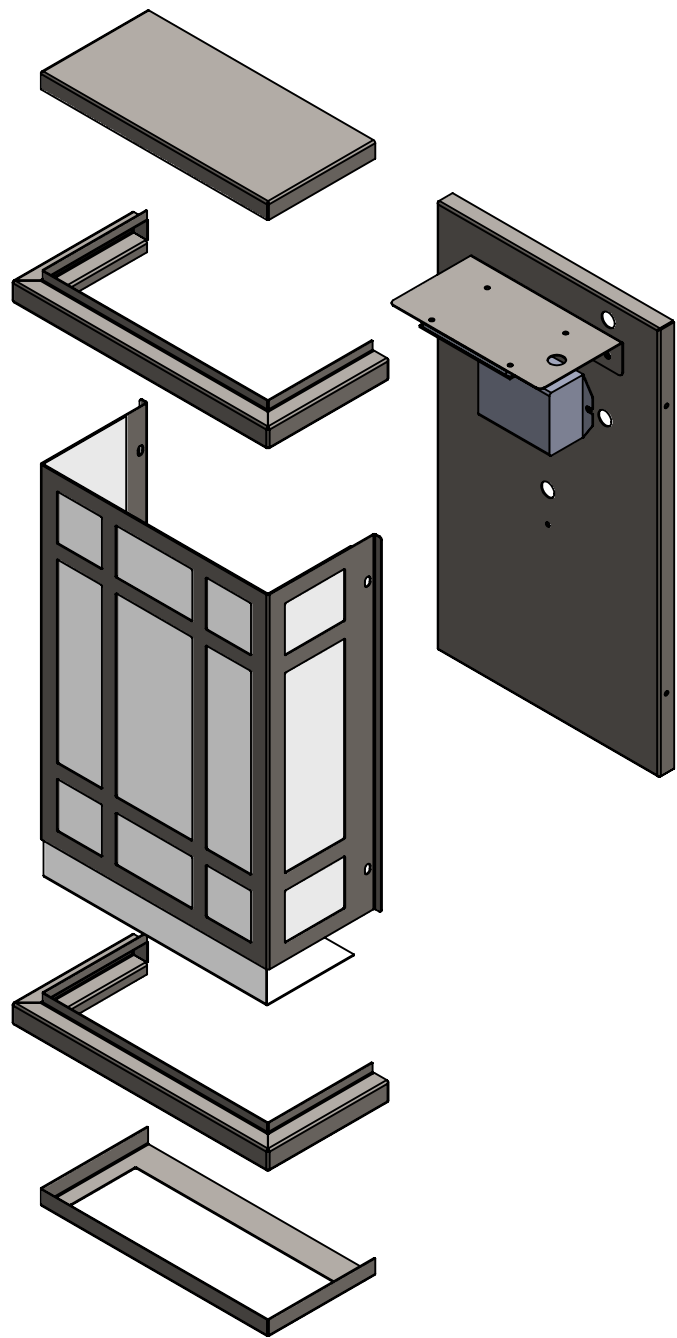

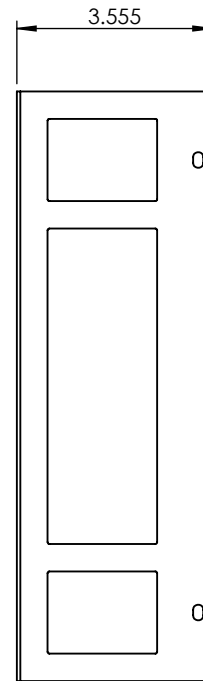
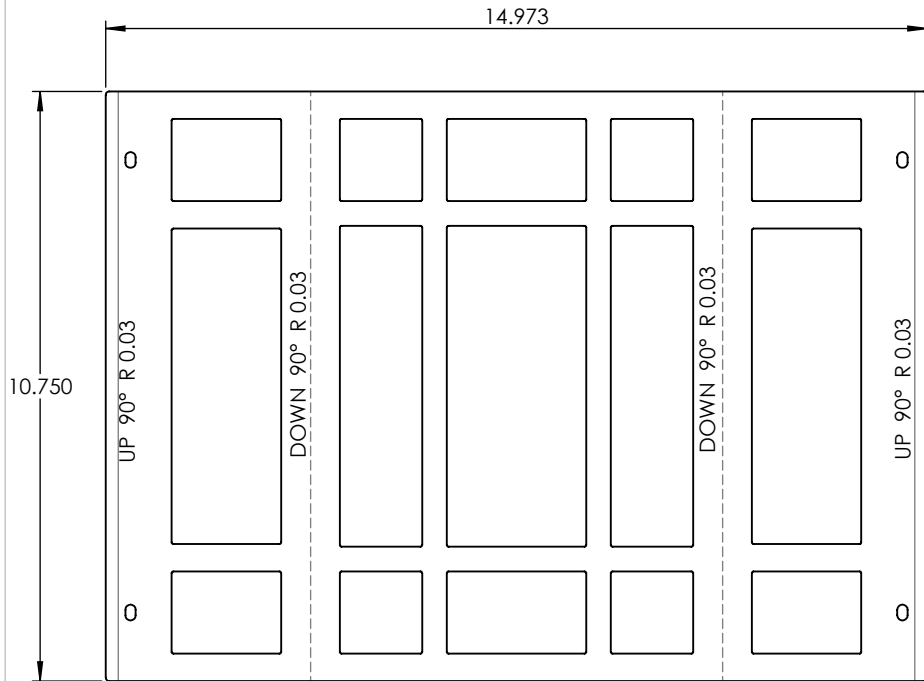
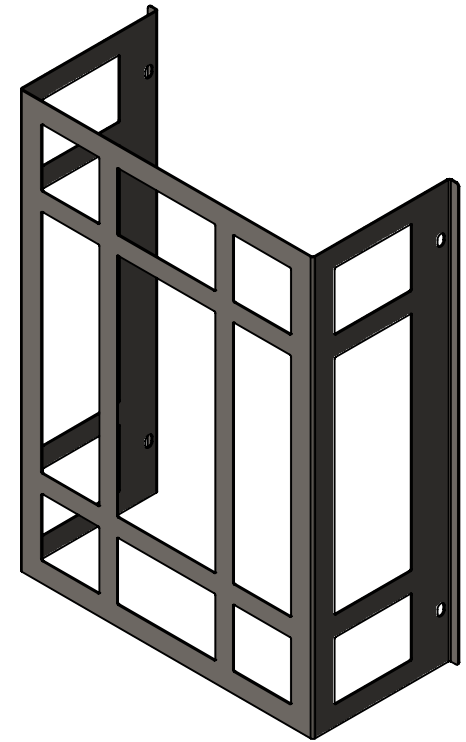
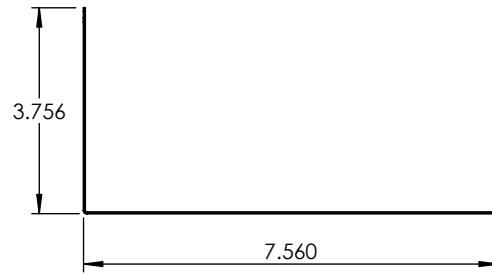
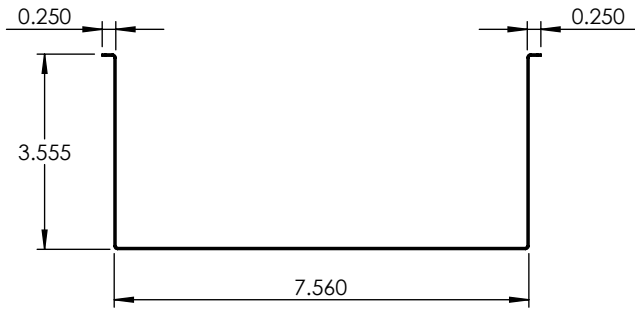

PROPRIETARY AND CONFIDENTIAL
 THE INFORMATION CONTAINED IN THIS DRAWING IS THE SOLE PROPERTY OF <INSERT COMPANY NAME HERE>. ANY REPRODUCTION IN PART OR AS A WHOLE WITHOUT THE WRITTEN PERMISSION OF <INSERT COMPANY NAME HERE> IS PROHIBITED.

		UNLESS OTHERWISE SPECIFIED:		NAME	DATE	22 GAUGE	
		DIMENSIONS ARE IN INCHES TOLERANCES: FRACTIONAL ± ANGULAR: MACH ± BEND ± TWO PLACE DECIMAL ± THREE PLACE DECIMAL ±		DRAWN			
		INTERPRET GEOMETRIC TOLERANCING PER:		CHECKED		SIZE DWG. NO. REV	
		MATERIAL OLI RUBBER BRONZE POWDERCOAT		ENG APPR.			
		FINISH		MFG APPR.		SCALE: 1:3.5 WEIGHT: SHEET 4 OF 7	
NEXT ASSY		USED ON		Q.A.			
APPLICATION		DO NOT SCALE DRAWING		COMMENTS:			

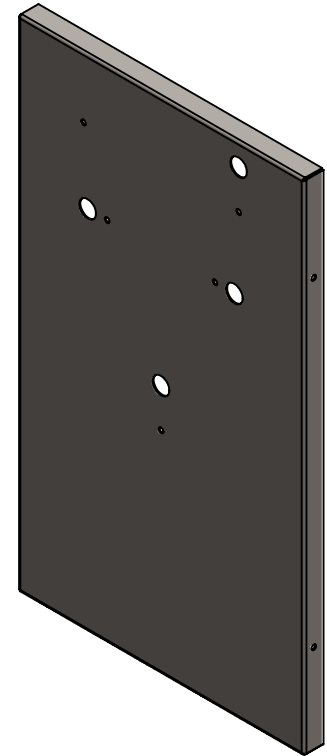
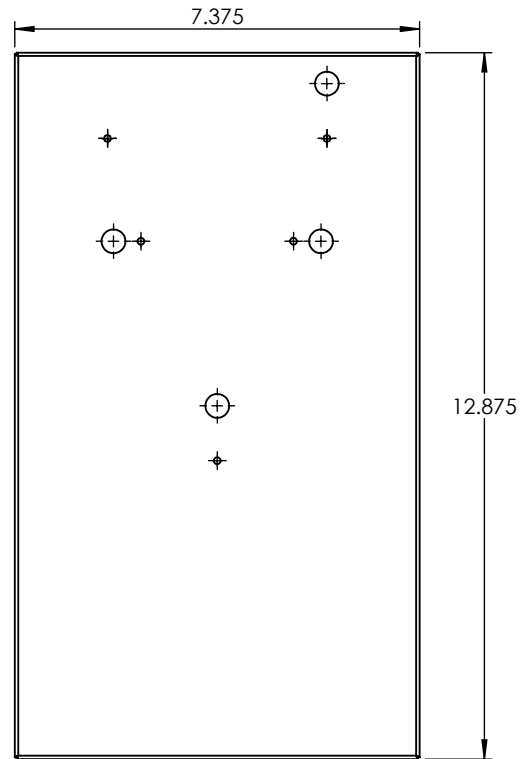
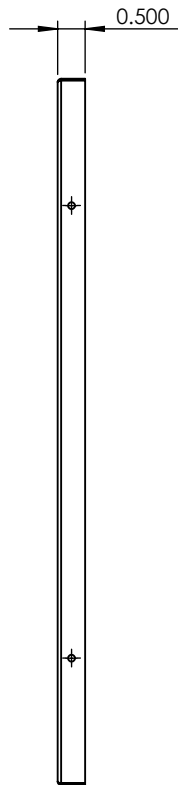
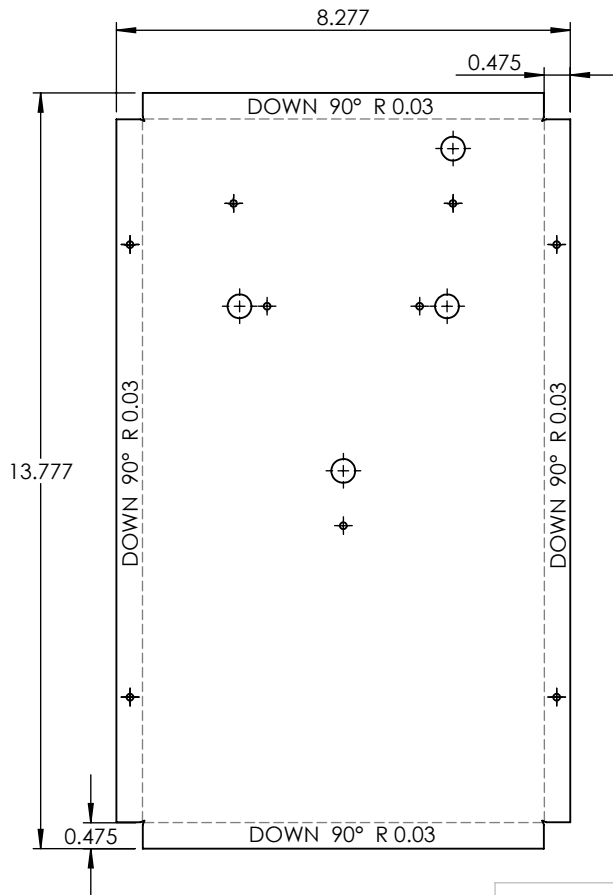

PROPRIETARY AND CONFIDENTIAL
 THE INFORMATION CONTAINED IN THIS DRAWING IS THE SOLE PROPERTY OF <INSERT COMPANY NAME HERE>. ANY REPRODUCTION IN PART OR AS A WHOLE WITHOUT THE WRITTEN PERMISSION OF <INSERT COMPANY NAME HERE> IS PROHIBITED.

		UNLESS OTHERWISE SPECIFIED:		NAME	DATE
		DIMENSIONS ARE IN INCHES	DRAWN		
		TOLERANCES:	CHECKED		
		FRACTIONAL ±	ENG APPR.		
		ANGULAR: MACH ± BEND ±	MFG APPR.		
		TWO PLACE DECIMAL ±	Q.A.		
		THREE PLACE DECIMAL ±	COMMENTS:		
		INTERPRET GEOMETRIC TOLERANCING PER:			
		MATERIAL			
NEXT ASSY	USED ON	FINISH			
APPLICATION		DO NOT SCALE DRAWING			

22 GAUGE		
TITLE:		
801209LS-MBK-A-EE-30K		
SIZE	DWG. NO.	REV
A		
SCALE: 1:3.5		WEIGHT:
		SHEET 5 OF 7

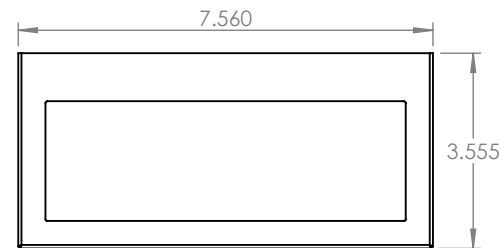
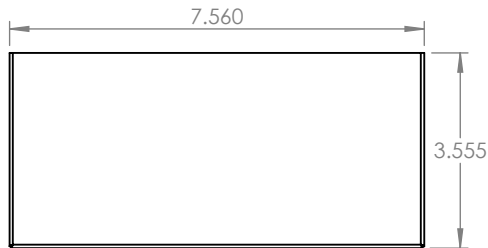
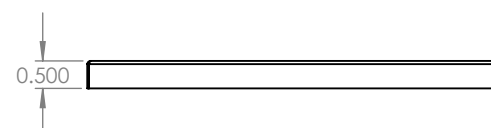
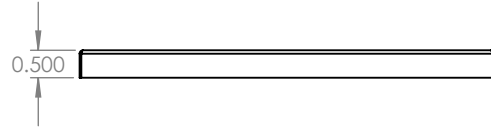
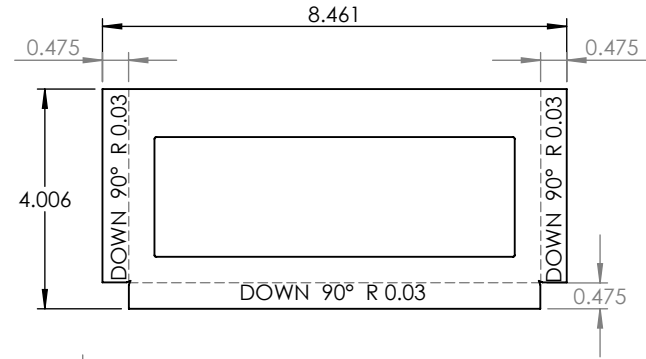
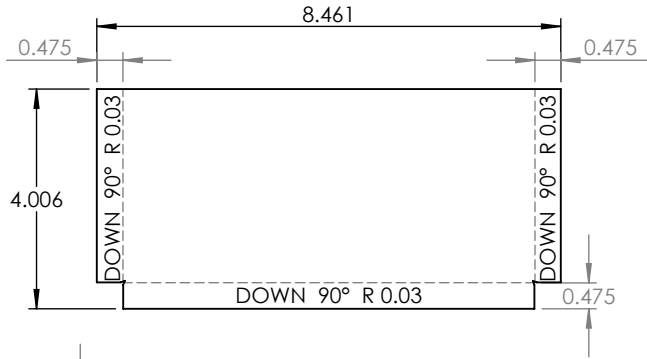
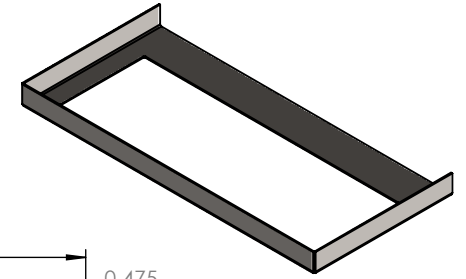
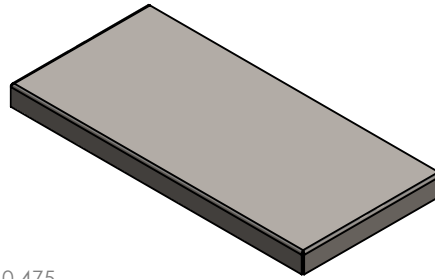

PROPRIETARY AND CONFIDENTIAL
 THE INFORMATION CONTAINED IN THIS DRAWING IS THE SOLE PROPERTY OF <INSERT COMPANY NAME HERE>. ANY REPRODUCTION IN PART OR AS A WHOLE WITHOUT THE WRITTEN PERMISSION OF <INSERT COMPANY NAME HERE> IS PROHIBITED.

		UNLESS OTHERWISE SPECIFIED:		NAME	DATE	22 GAUGE	
		DIMENSIONS ARE IN INCHES TOLERANCES: FRACTIONAL ± ANGULAR: MACH ± BEND ± TWO PLACE DECIMAL ± THREE PLACE DECIMAL ±		DRAWN			
		INTERPRET GEOMETRIC TOLERANCING PER:		CHECKED			
		MATERIAL		ENG APPR.			
		FINISH		MFG APPR.		SIZE DWG. NO. REV	
NEXT ASSY	USED ON			Q.A.			
APPLICATION		DO NOT SCALE DRAWING		COMMENTS:		SCALE: 1:3.5 WEIGHT: SHEET 6 OF 7	

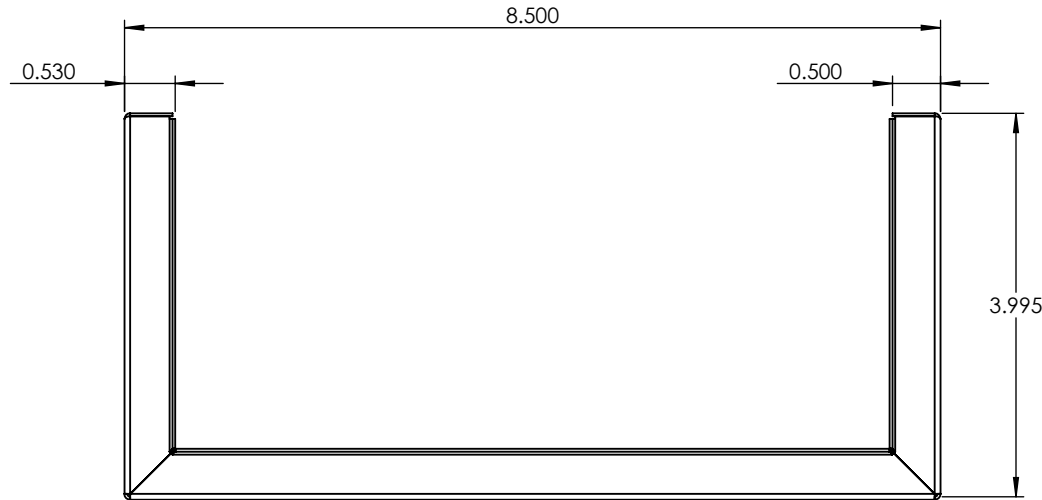
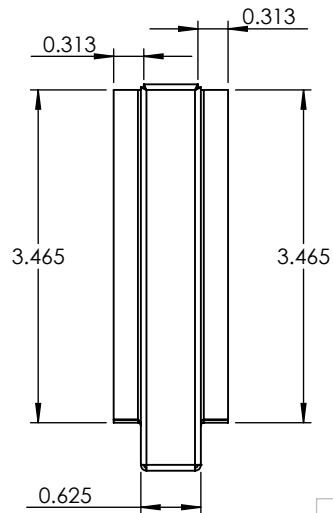
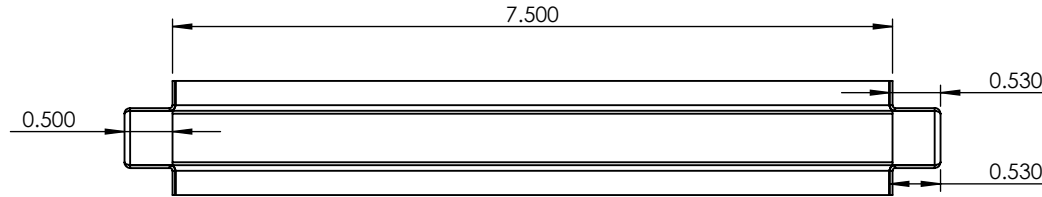
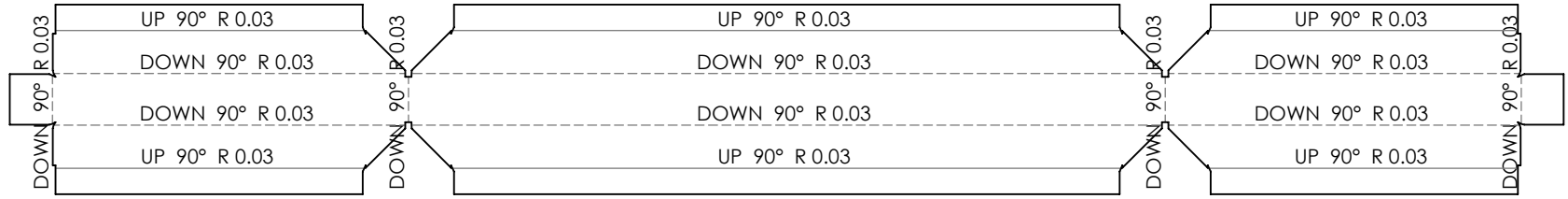

PROPRIETARY AND CONFIDENTIAL
 THE INFORMATION CONTAINED IN THIS DRAWING IS THE SOLE PROPERTY OF <INSERT COMPANY NAME HERE>. ANY REPRODUCTION IN PART OR AS A WHOLE WITHOUT THE WRITTEN PERMISSION OF <INSERT COMPANY NAME HERE> IS PROHIBITED.

		UNLESS OTHERWISE SPECIFIED:	NAME	DATE	22 GAUGE	
		DIMENSIONS ARE IN INCHES TOLERANCES: FRACTIONAL ± ANGULAR: MACH ± BEND ± TWO PLACE DECIMAL ± THREE PLACE DECIMAL ±	DRAWN			
		INTERPRET GEOMETRIC TOLERANCING PER:	CHECKED		801209LS-MBK-A-EE-30K	
		MATERIAL	ENG APPR.			
NEXT ASSY	USED ON	FINISH	MFG APPR.		SIZE	DWG. NO.
APPLICATION		DO NOT SCALE DRAWING	Q.A.		A	
			COMMENTS:		SCALE: 1:2	WEIGHT:
					SHEET 7 OF 7	