

ITEM NO.	PART NUMBER	DESCRIPTION	QTY.	CUT
1	CO-WMD-10X5-12W-MBK-A-WET-30K-BACKPLATE	22 GAUGE	1	
2	CO-WMD-10X5-12W-MBK-A-WET-30K-FIREPLATE	22 GAUGE	1	
3	CO-WMD-10X5-12W-MBK-A-WET-30K-FRAME	22 GAUGE	1	
4	CO-WMD-10X5-12W-MBK-A-WET-30K-TOP END CAP	22 GAUGE	1	
5	CO-WMD-10X5-12W-MBK-A-WET-30K-BOTTOM END CAP	22 GAUGE	1	
6	CO-WMD-10X5-12W-MBK-A-WET-30K-ACRYLIC	ACRYLIC	1	
7	EspenTECH_120277V_SKU808076	DRIVER	1	
8	AlfaLED_PN1010_RevD	LED	2	

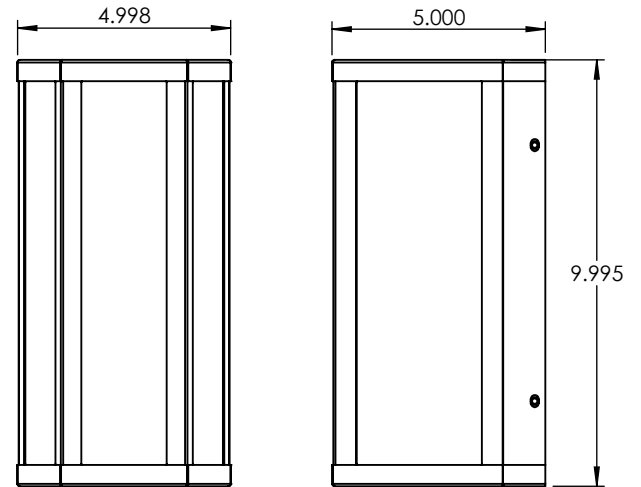
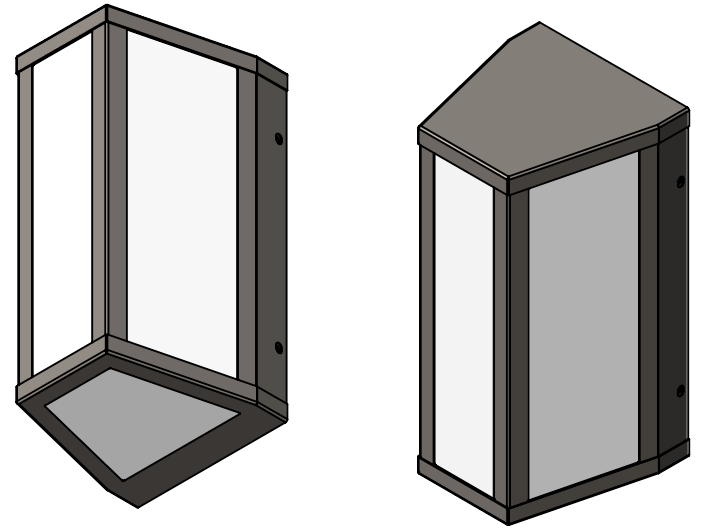
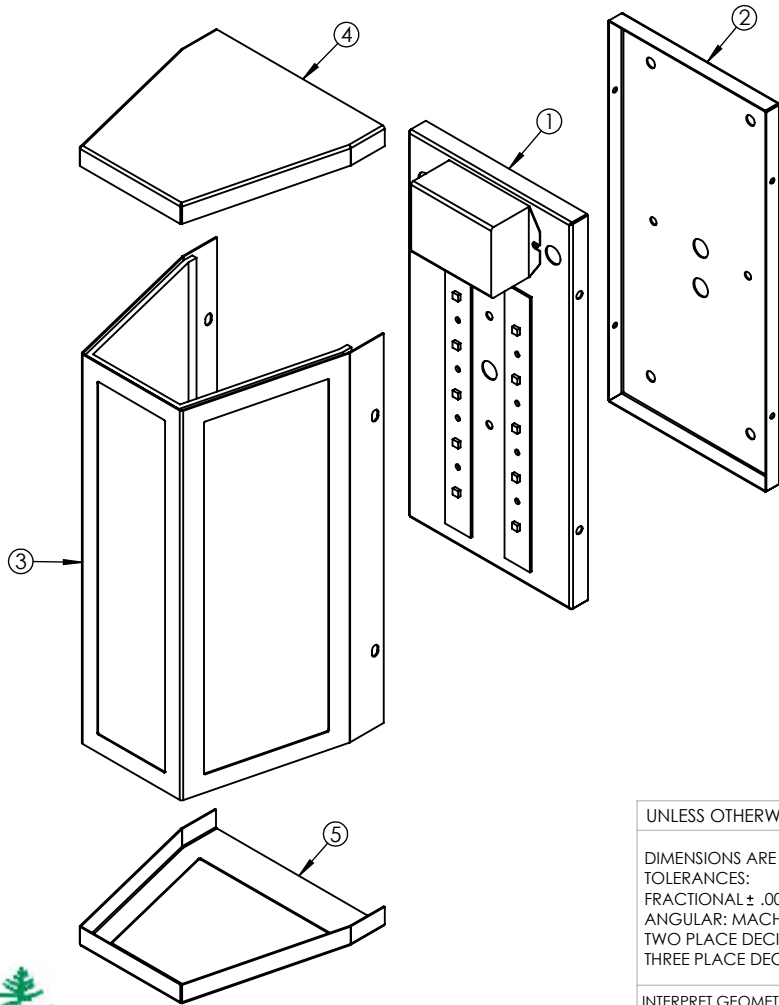

UNLESS OTHERWISE SPECIFIED:

DIMENSIONS ARE IN INCHES
 TOLERANCES:
 FRACTIONAL ± .003
 ANGULAR: MACH ± .01 BEND ±
 TWO PLACE DECIMAL ±
 THREE PLACE DECIMAL ±.001

INTERPRET GEOMETRIC
 TOLERANCING PER:

MATERIAL

FINISH

	NAME	DATE
DRAWN		
CHECKED		
ENG APPR.		
MFG APPR.		
Q.A.		
COMMENTS:		

TITLE:

CO-WMD-10X5-12W-MBK-A-WET-30K

SIZE	DWG. NO.	REV
A	TICKET 25152	

SCALE: 1:4	WEIGHT:	SHEET 1 OF 6
------------	---------	--------------



ALL BEND RADIUS .030"

APPLICATION

DO NOT SCALE DRAWING

5

4

3

2

1

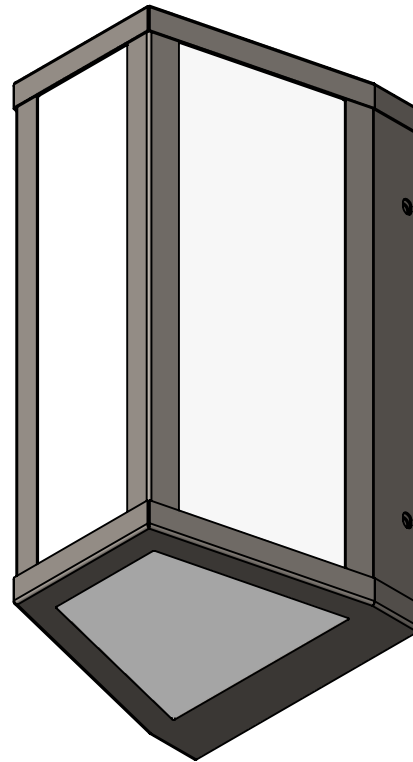
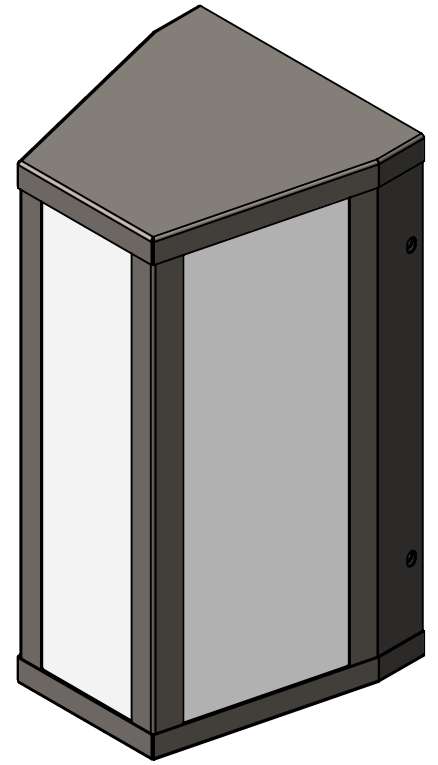
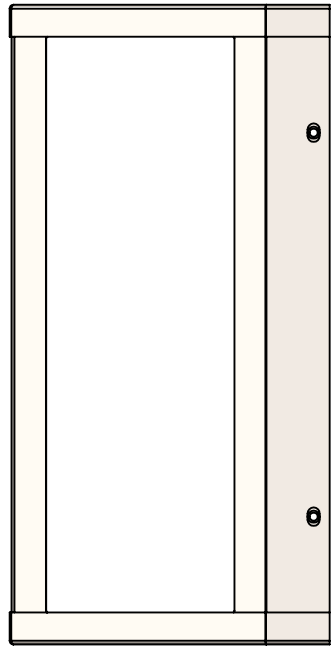
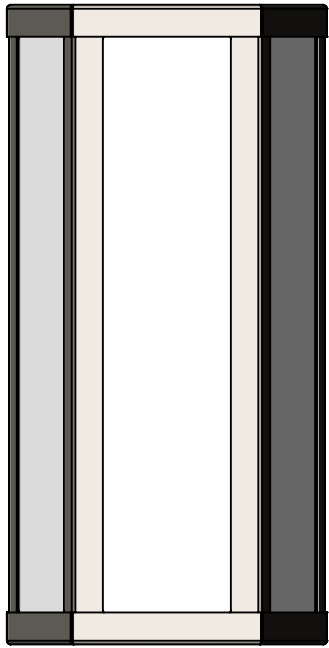

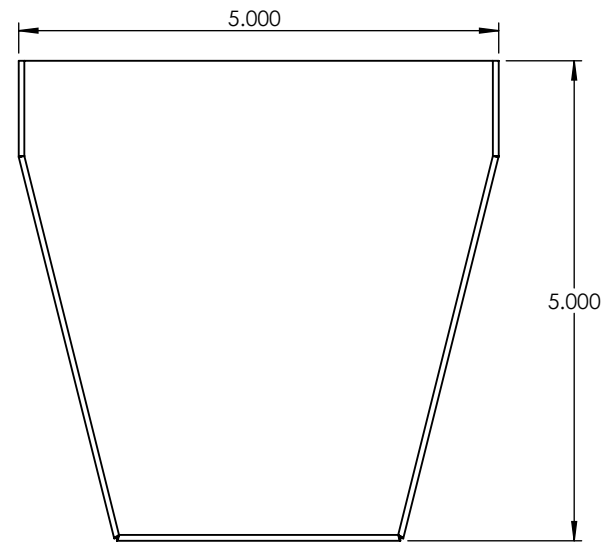
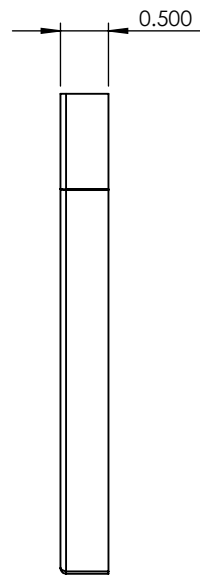
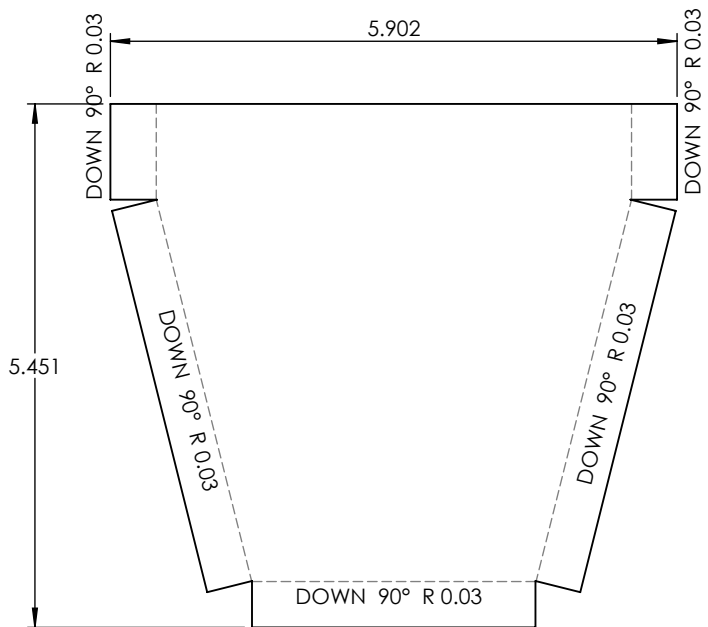
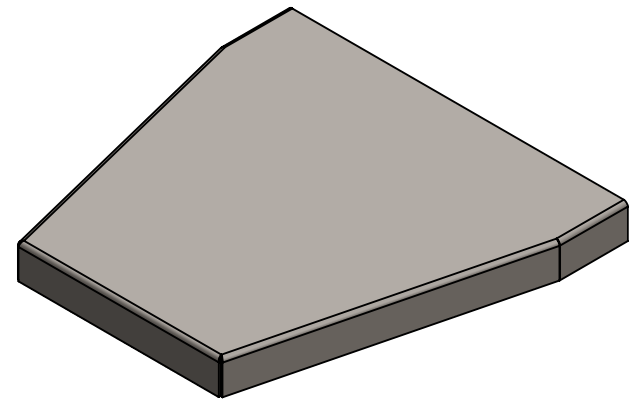

PROPRIETARY AND CONFIDENTIAL
 THE INFORMATION CONTAINED IN THIS DRAWING IS THE SOLE PROPERTY OF <INSERT COMPANY NAME HERE>. ANY REPRODUCTION IN PART OR AS A WHOLE WITHOUT THE WRITTEN PERMISSION OF <INSERT COMPANY NAME HERE> IS PROHIBITED.

		UNLESS OTHERWISE SPECIFIED:	NAME	DATE
		DIMENSIONS ARE IN INCHES	DRAWN	
		TOLERANCES:	CHECKED	
		FRACTIONAL ±	ENG APPR.	
		ANGULAR: MACH ± BEND ±	MFG APPR.	
		TWO PLACE DECIMAL ±	Q.A.	
		THREE PLACE DECIMAL ±	COMMENTS:	
		INTERPRET GEOMETRIC TOLERANCING PER:		
		MATERIAL		
	NEXT ASSY	USED ON		
		FINISH		
	APPLICATION	DO NOT SCALE DRAWING		

22 GAUGE

TITLE:
 CO-WMD-10X5-12W-MBK-A-WET-30K

SIZE	DWG. NO.	REV
A		
SCALE: 1:2	WEIGHT:	SHEET 3 OF 6

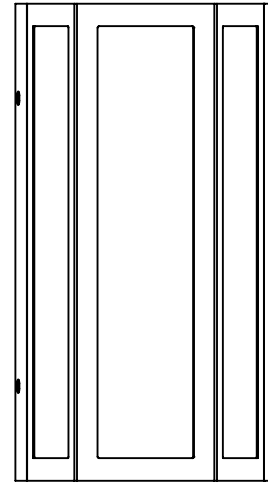
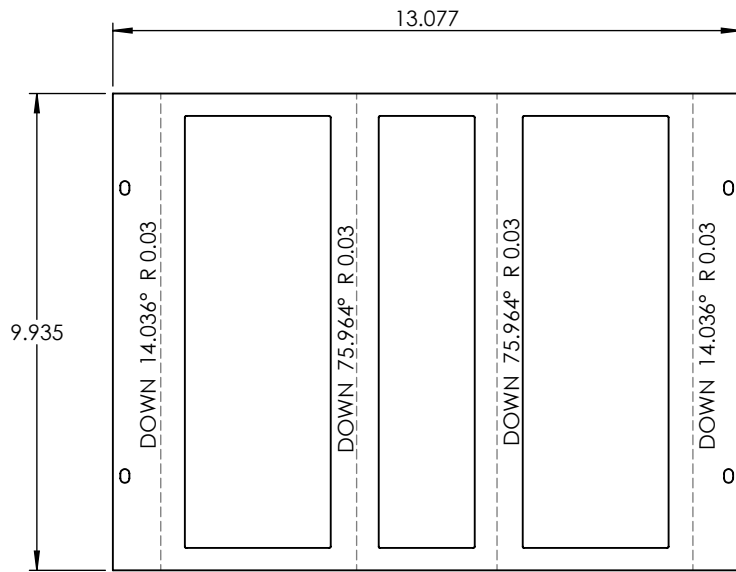
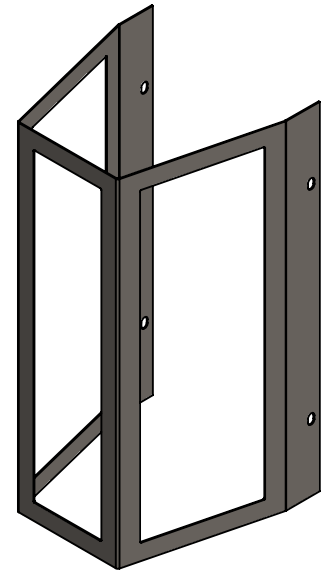
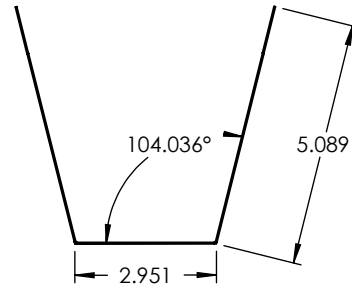
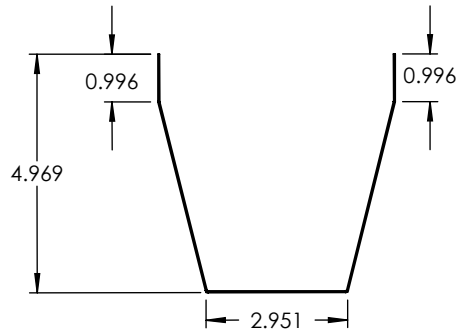

PROPRIETARY AND CONFIDENTIAL
 THE INFORMATION CONTAINED IN THIS DRAWING IS THE SOLE PROPERTY OF <INSERT COMPANY NAME HERE>. ANY REPRODUCTION IN PART OR AS A WHOLE WITHOUT THE WRITTEN PERMISSION OF <INSERT COMPANY NAME HERE> IS PROHIBITED.

		UNLESS OTHERWISE SPECIFIED:	NAME	DATE	22 GAUGE	
		DIMENSIONS ARE IN INCHES TOLERANCES: FRACTIONAL ± ANGULAR: MACH ± BEND ± TWO PLACE DECIMAL ± THREE PLACE DECIMAL ±	DRAWN			
		INTERPRET GEOMETRIC TOLERANCING PER:	CHECKED		SIZE DWG. NO. REV	
		MATERIAL	ENG APPR.			
		FINISH	MFG APPR.			
NEXT ASSY	USED ON		Q.A.			
APPLICATION		DO NOT SCALE DRAWING	COMMENTS:			

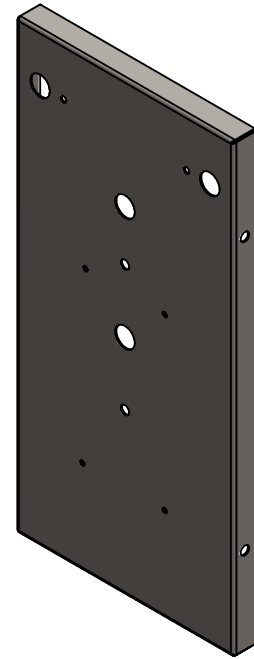
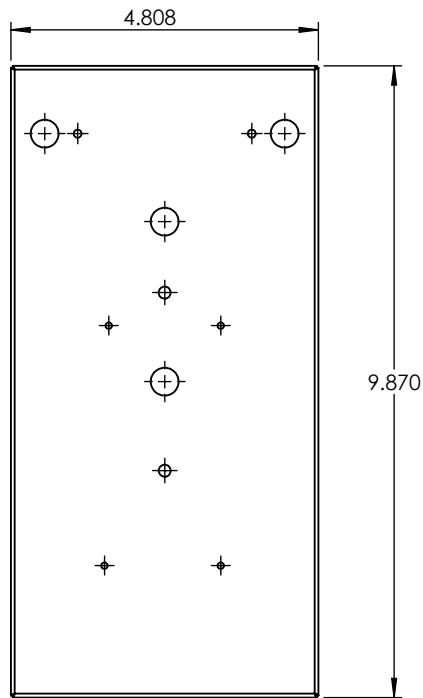
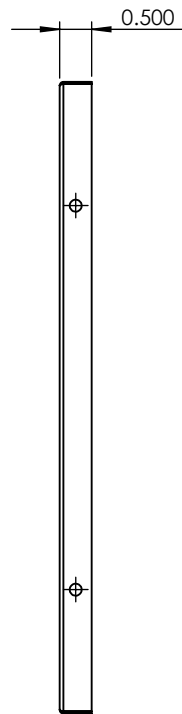
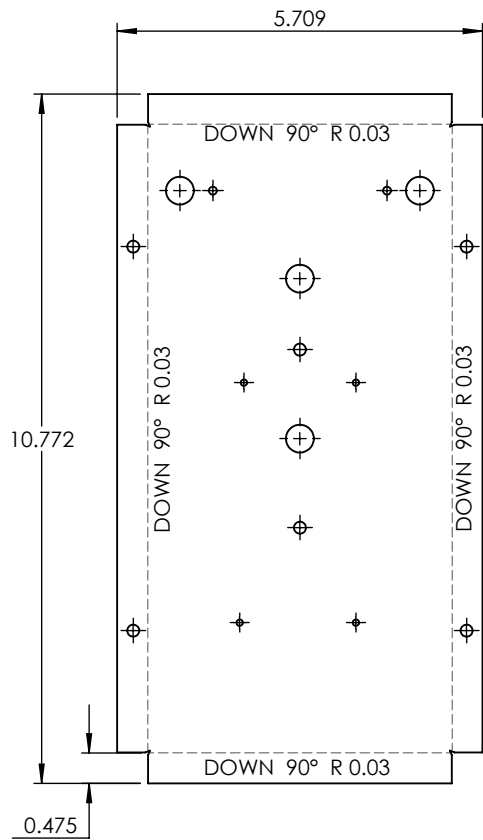

PROPRIETARY AND CONFIDENTIAL
 THE INFORMATION CONTAINED IN THIS DRAWING IS THE SOLE PROPERTY OF <INSERT COMPANY NAME HERE>. ANY REPRODUCTION IN PART OR AS A WHOLE WITHOUT THE WRITTEN PERMISSION OF <INSERT COMPANY NAME HERE> IS PROHIBITED.

		UNLESS OTHERWISE SPECIFIED:	NAME	DATE	22 GAUGE	
		DIMENSIONS ARE IN INCHES TOLERANCES: FRACTIONAL ± ANGULAR: MACH ± BEND ± TWO PLACE DECIMAL ± THREE PLACE DECIMAL ±	DRAWN			
		INTERPRET GEOMETRIC TOLERANCING PER:	CHECKED		SIZE DWG. NO. REV	
		MATERIAL	ENG APPR.			
		FINISH	MFG APPR.			
NEXT ASSY	USED ON		Q.A.			
APPLICATION		DO NOT SCALE DRAWING	COMMENTS:			

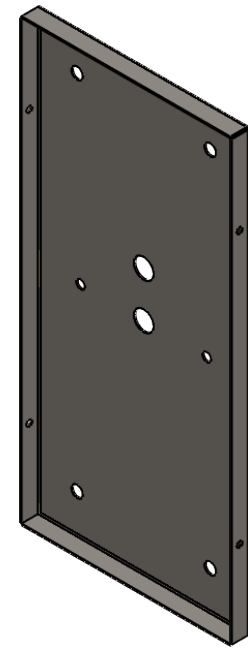
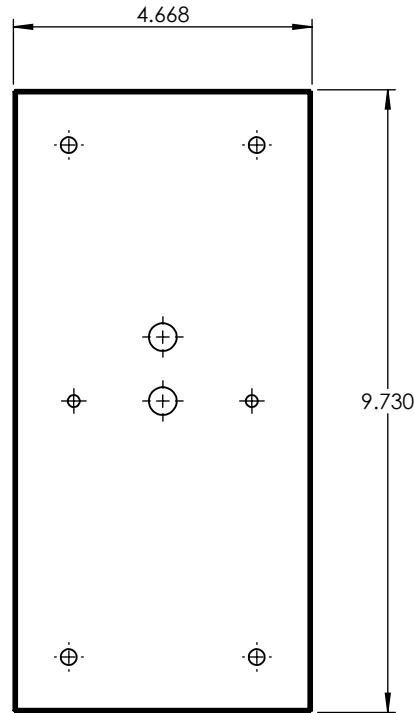
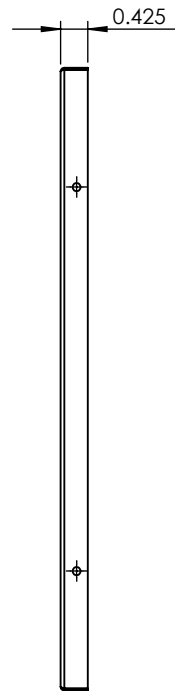
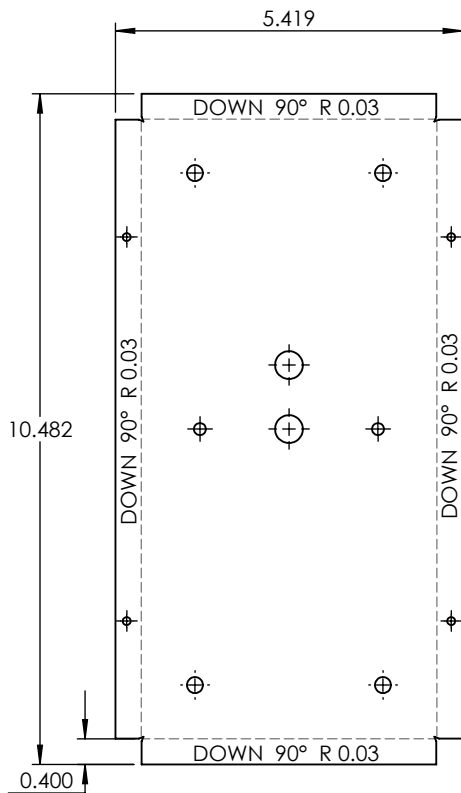

PROPRIETARY AND CONFIDENTIAL
 THE INFORMATION CONTAINED IN THIS DRAWING IS THE SOLE PROPERTY OF <INSERT COMPANY NAME HERE>. ANY REPRODUCTION IN PART OR AS A WHOLE WITHOUT THE WRITTEN PERMISSION OF <INSERT COMPANY NAME HERE> IS PROHIBITED.

		UNLESS OTHERWISE SPECIFIED:	NAME	DATE	22 GAUGE	
		DIMENSIONS ARE IN INCHES TOLERANCES: FRACTIONAL ± ANGULAR: MACH ± BEND ± TWO PLACE DECIMAL ± THREE PLACE DECIMAL ±	DRAWN			
		INTERPRET GEOMETRIC TOLERANCING PER:	CHECKED		SIZE DWG. NO. REV	
		MATERIAL	ENG APPR.			
NEXT ASSY	USED ON	FINISH	MFG APPR.		SCALE: 1:3 WEIGHT: SHEET 6 OF 6	
APPLICATION		DO NOT SCALE DRAWING	Q.A.			
			COMMENTS:			