



PROJECT NAME: _____

PROJECT TYPE: _____

*SKIP SECTION IF OPTION DOES NOT APPLY

MODEL #	/	/	/	/	/	/	/	/	/
EXAMPLE:	A EDS12	B MG	C E13	D SQ½"	E 23	F 100INC	G BAX	H GR12	I 44

A - SHADES

ANGLE SHADES

- EA807
- EA810
- EA812
- EA814

DOME SHADES

- EDS07
- EDS10
- EDS12
- EDS14

EMBLEM SHADES

- EM707
- EM710
- EM710S
- EM712
- EM718

CONE SHADES

- ECN08
- ECN12
- ECN14

ELLIPTICAL SHADES

- ELS10
- ELS12
- ELS14

B - FINISH OPTION

ALL PURPOSE

- AB – ARCHITECTURAL BRONZE
- ORB – OIL RUBBED BRONZE
- MBK – MATTE BLACK
- MW – MATTE WHITE
- MG – METALLIC GREY
- MN – METALLIC NICKEL
- SB – SATIN BRASS
- CM – COPPER METALLIC
- CV – COPPER VEIN
- GV – GOLD VEIN
- SV – SILVER VEIN

GLOSS FINISHES

- GW – GLOSS WHITE
- GBK – GLOSS BLACK
- GRN – GLOSS GREEN
- RD – GLOSS RED
- BL – GLOSS BLUE
- NBL – GLOSS NAVY BLUE
- YL – GLOSS YELLOW

TEXTURED (EXTERIOR)

- TW – TEXTURED WHITE
- TBK – TEXTURED BLACK
- TBR – TEXTURED BRONZE
- TR – TEXTURED RUST
- TVP – TEXTURED VERDE PATINA

C - MOUNTING

1/2" RM EXTENSIONS

E1	E22	E34 **
E2	E23	E35 **
E2S	E24	E36 **
E3	E31 **	E37 **
E4	E32 **	E38 **
E18A	E33 **	

3/4" RM EXTENSIONS

E3A	E9	E20
E4A	E10	E21
E5	E11	E25
E6	E12	E38
E7	E13	E15
E8	E19	

***E14- CREATE YOUR OWN**
(EVERGREEN WILL TAKE YOUR SKETCH AND FABRICATE A CUSTOM ARM EXTENSION TO MEET YOUR NEEDS).

D – MOUNTING ADD-ONS

- SMSWL TRB¾"
- LGSWL SQ½"
- TRB¾"SQ¾"

E – MOUNTING COLOR

SEE SECTION "B" FOR COLOR OPTIONS.

F – LIGHT SOURCE

INCANDESCENT (INC)

- 60W
- 100W
- GU24**
- 13W
- 26W
- 32W
- 42W

LIGHT EMITTED DIODE (LED)

- 7W
- 12W
- 25W

G - ACCESSORIES

CL3	FRT4	RE3
CL4	AH3	RE4
CLT3	AH4	BL3
CLT4	PR3	BL4
FR3	PR4	GR3
FR4	PRT3	GR4
FRT3	PRT4	

H - ACCESSORIES

- GR7 GR14
- GR8 GR18
- GR10 GU-1
- GR12 GU-2

I – ACCESSORY COLOR

SEE SECTION "B" FOR COLOR OPTIONS.

NOTES

ACCORDING TO THE LIGHT SOURCE, THE BACKPLATE MAY VARY IN SIZE.

* ALL ARMS COME WITH A CAST BACKPLATE (CB½", CB¾", LWTM, CFWTM, ECT.)



A- SHADES

ANGLE SHADES

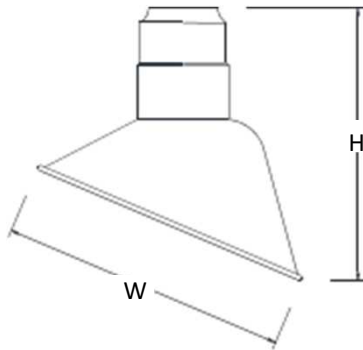

	HEIGHT	WIDTH
EA807	8"	7"
EA810	10.75"	10"
EA812	12.5"	12"
EA814	14"	14"

DOME SHADES

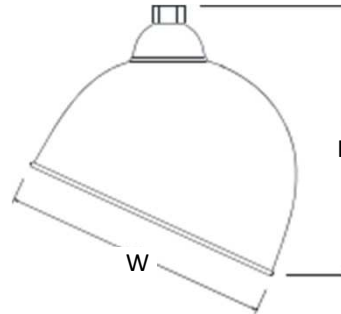

	HEIGHT	WIDTH
EDS07	8.5"	7"
EDS10	10.25"	10"
EDS12	13"	12"
EDS14	13"	14"

EMBLEM SHADES

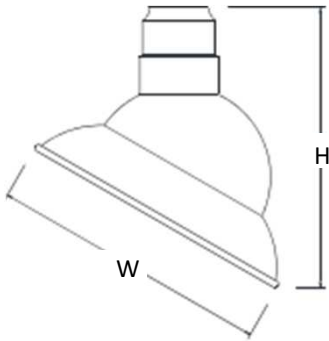

	HEIGHT	WIDTH
EM710	11.25"	10"
EM712	12.5"	12"
EM718	18"	18"

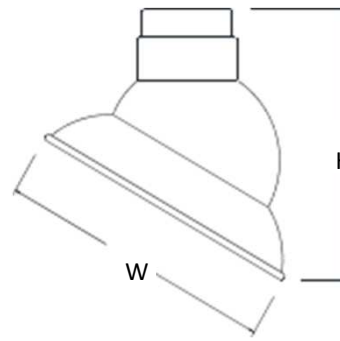

	HEIGHT	WIDTH
EM710S	9.5"	10"

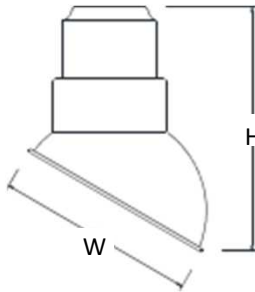

	HEIGHT	WIDTH
EM707	8.5"	7"

CONE SHADES

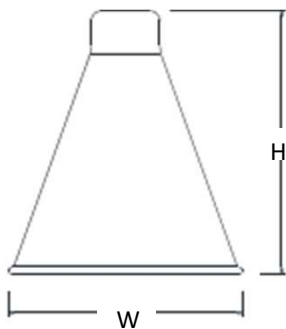

	HEIGHT	WIDTH
ECN08	8.5"	8"
ECN12	9.25"	12"
ECN14	7.5"	14"

ELLIPTICAL SHADES

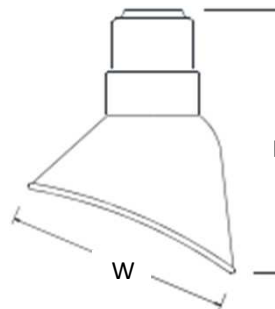

	HEIGHT	WIDTH
ELS10	10.75"	9"
ELS12	12.5"	11"
ELS14	14"	13"

EVERGREEN SIGN LIGHT CATALOG

B- FINISHES

EVERGREEN USES A DURABLE POWDER COATING TO FINISH THEIR SHADES. THE POWDER COATING PROCESS ALLOWS THE SHADES TO HAVE A THICKER COATING OF PAINT, WHICH ENSURES A HIGHER QUALITY PROTECTIVE COATING. EVERGREEN OFFERS A WIDE RANGE OF COLORS TO CHOOSE FROM. CALL FOR CUSTOM COLOR OPTIONS.



AB – ARCHITECTURAL BRONZE



ORB – OIL RUBBED BRONZE



MBK – MATTE BLACK

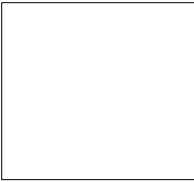

MW – MATTE WHITE

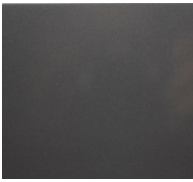

MG – METALLIC GREY



MN – METALLIC NICKEL



SB – SATIN BRASS



CM – COPPER METALLIC



CV – COPPER VEIN



GV – GOLD VEIN

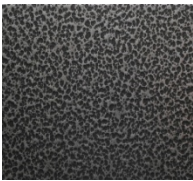

SV – SILVER VEIN

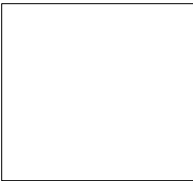

GW – GLOSS WHITE



GBK – GLOSS BLACK



GRN – GLOSS GREEN



RD – GLOSS RED



BL – GLOSS BLUE



NBL – GLOSS NAVY BLUE



YL – GLOSS YELLOW

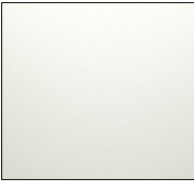

TW – TEXTURED WHITE



TBK – TEXTURED BLACK



TBR – TEXTURED BRONZE



TR – TEXTURED RUST



TVP – TEXTURED VERDE PATINA

*ALL FINISH COLORS FEATURE A WHITE INTERIOR OF THE SHADE.

C – MOUNTING OPTIONS

1/2" ARM EXTENSIONS

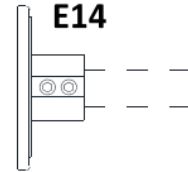
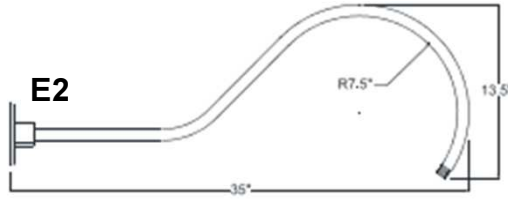
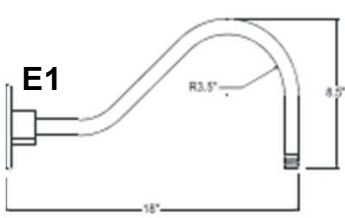

Evergreen will take your sketch and fabricate a custom arm extension to meet your needs.

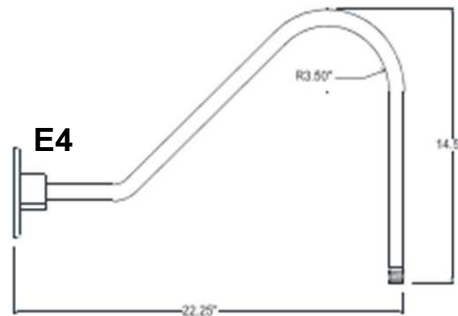
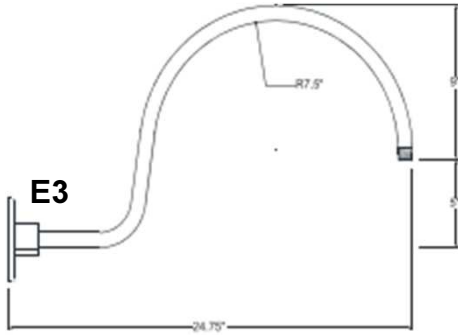

Evergreen will take your sketch and fabricate a custom arm extension to meet your needs.

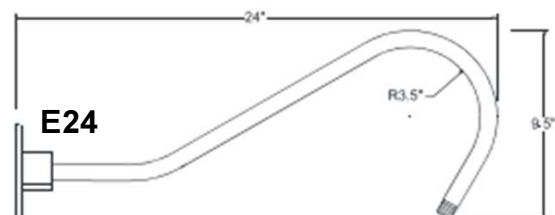
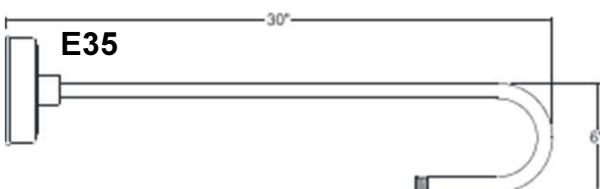
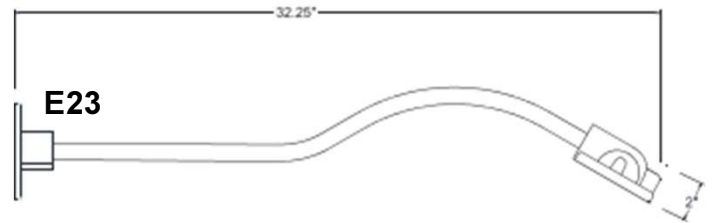
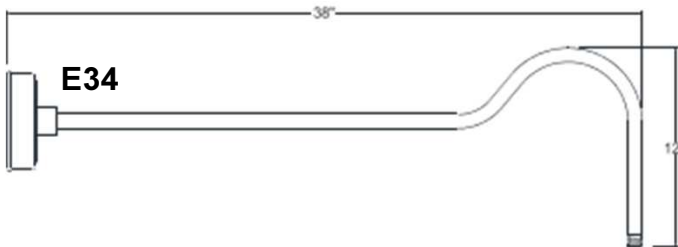
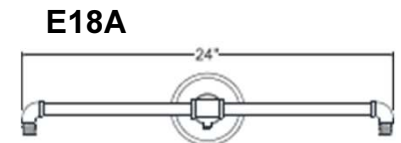
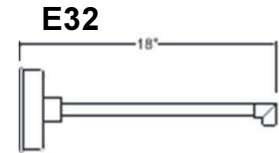
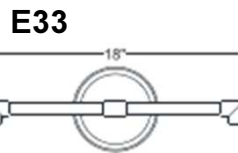
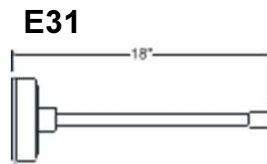
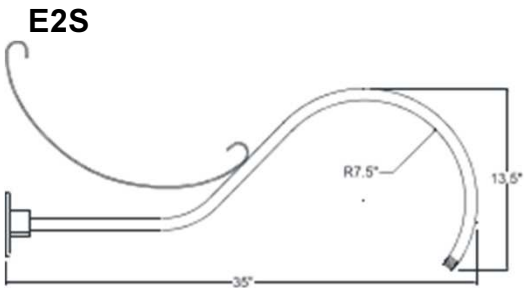
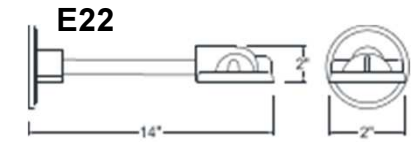

C-MOUNTING OPTIONS (CONTINUED)

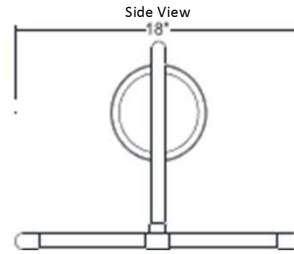
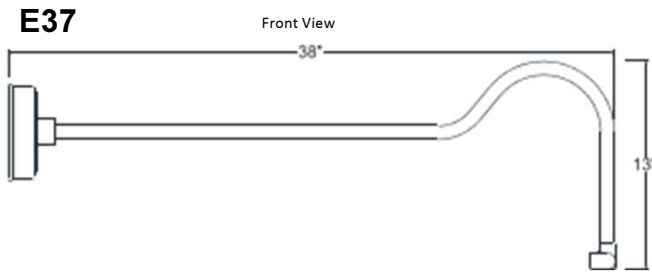
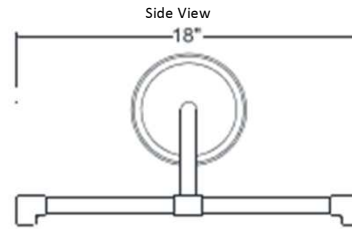
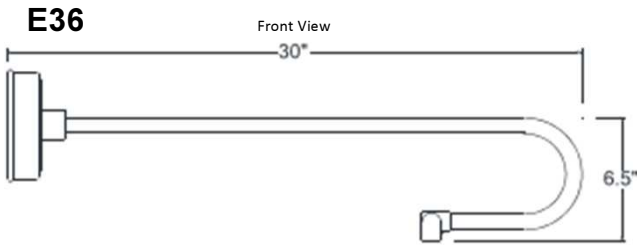

3/4" ARM EXTENSIONS

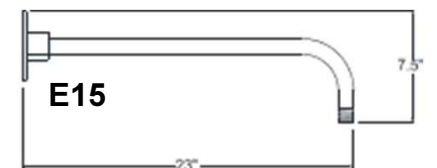
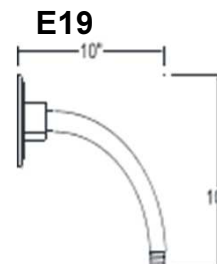
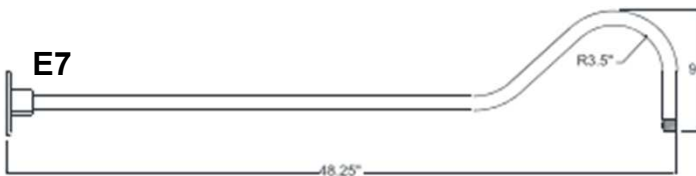
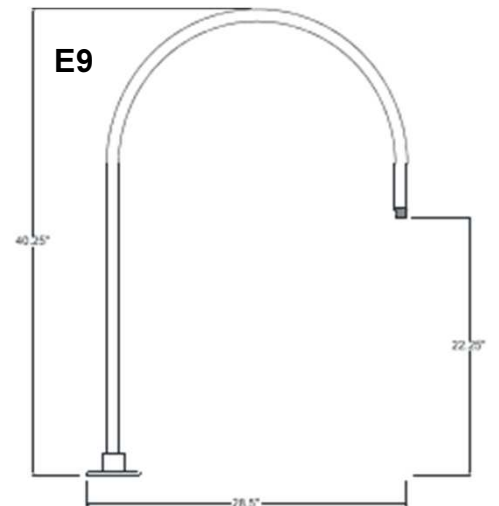
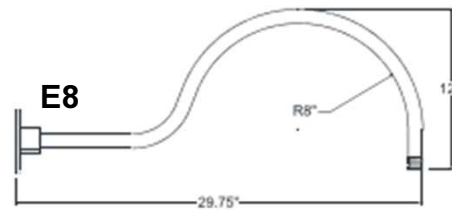
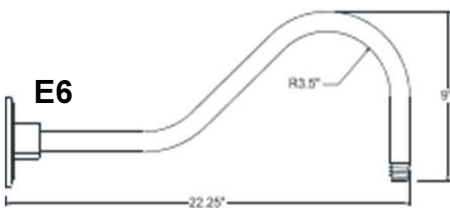
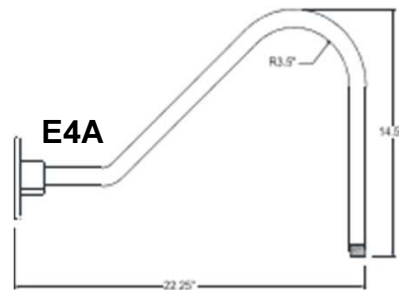
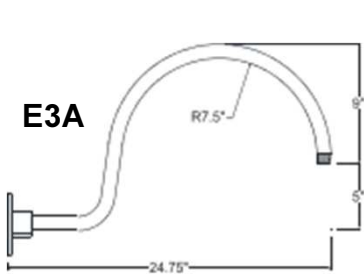

C-MOUNTING OPTIONS (CONTINUED)

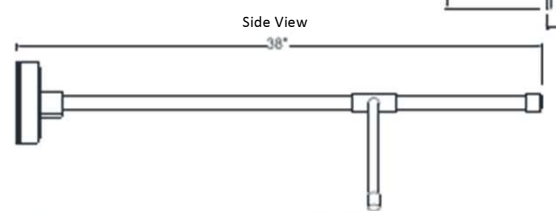
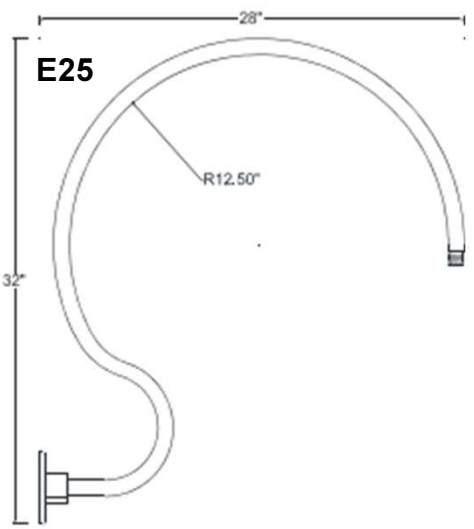
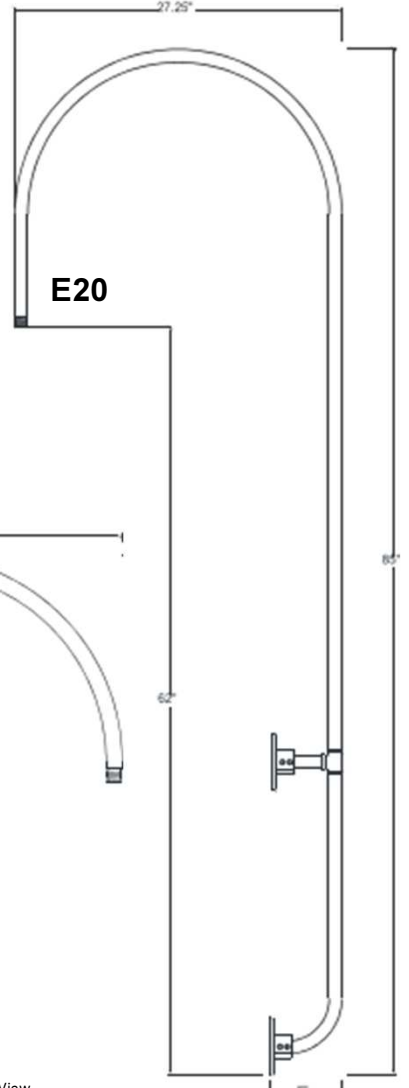
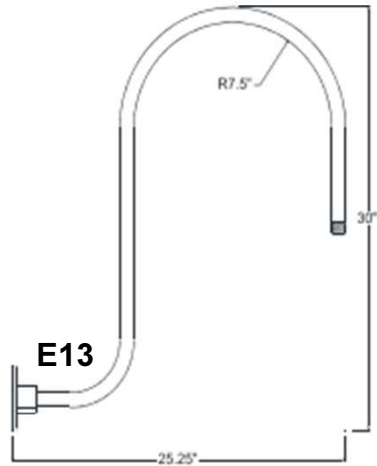
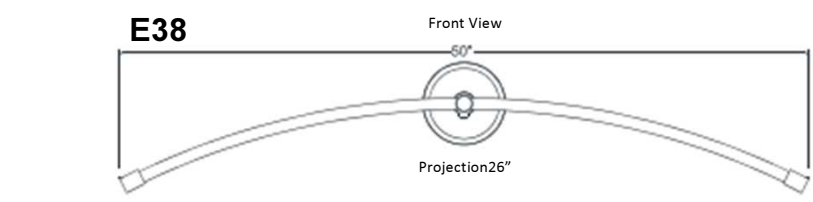
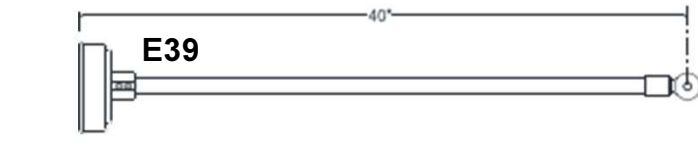
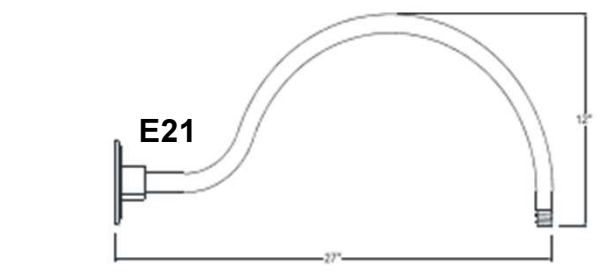
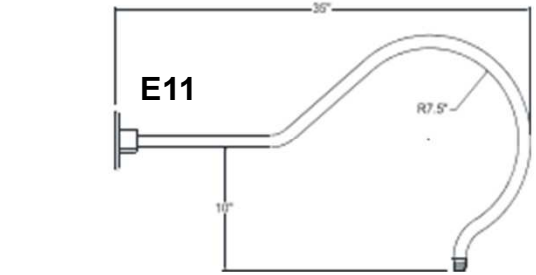
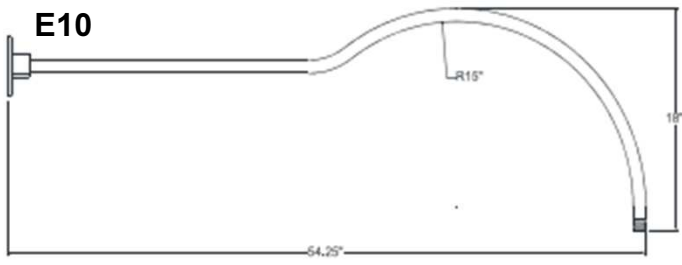

D- MOUNTING ADD-ONS

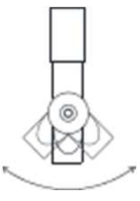

SMSWL 1/2" NPT swivel
For all arms 7" wide in diameter or smaller

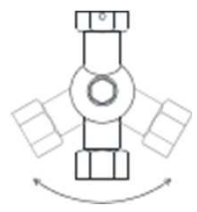

LGSWL 1/2" NPT swivel
For all arms greater than 7" wide in diameter

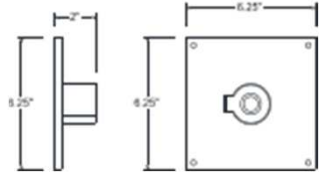

SQ 1/2" Square Backplate
SQ 3/4" Square Backplate
(Additional charges may apply)



TRB 1/2" 4' Cable Support
TRB 3/4" 4' Cable Support

F_ LIGHT SOURCE

OPTION	WATTAGE	LUMENS		CRI	VOLTAGE	DIMMING
LEDS (LED)						
LED7W	7W	700	840	>90	120-277 VAC	0-10V
LED12W	12W	1200	1440	>90	120-277 VAC	0-10V
LED25W	25W	2500	3000	>90	120-277 VAC	0-10V

INCANDESCENT						
OPTION	WATTAGE	LUMENS		CRI	VOLTAGE	DIMMING
60WINC	60W	PER BULB SPECS		>90	120-277 VAC	N/A
100WINC	100W	PER BULB SPECS		>90	120-277 VAC	N/A

COMPACT FLUORESCENT GU24 BASE						
OPTION	WATTAGE	LUMENS		CRI	VOLTAGE	DIMMING
CF13W	13W	PER BULB SPECS		>90	120-277 VAC	N/A
CF26W	26W	PER BULB SPECS		>90	120-277 VAC	N/A
CF32W	32W	PER BULB SPECS		>90	120-277 VAC	N/A
CF42W	42W	PER BULB SPECS		>90	120-277 VAC	N/A

H - ACCESSORIES

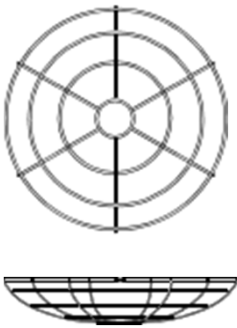

- GR7** 7" WIRE GRILL
- GR8** 8" WIRE GRILL
- GR10** 10" WIREGRILL
- GR12** 12" WIRE GRILL
- GR14** 14" WIRE GRILL
- GR16** 16" WIRE GRILL
- GR18** 18" WIRE GRILL

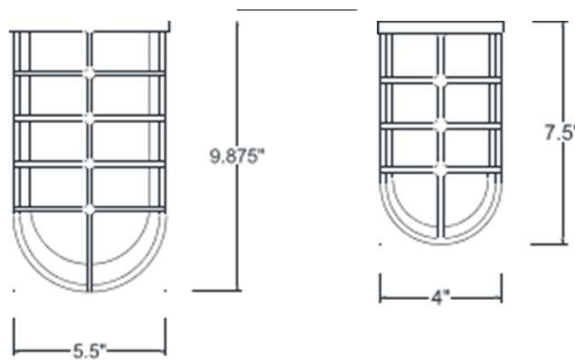

GU-2 WIRE GUARD

GU-1 CAST GUARD

GLASS – DIMENSIONS	
3" GLASS	
Diameter	3.34"
Height	6.93"
Fitter	3.29"
4" GLASS	
Diameter	4.34"
Height	8.37"
Fitter	4.29"